



EN

HOTAK

NINGBO LONGYUAN TOOLS CO., LTD

HOTAK

General programme EN

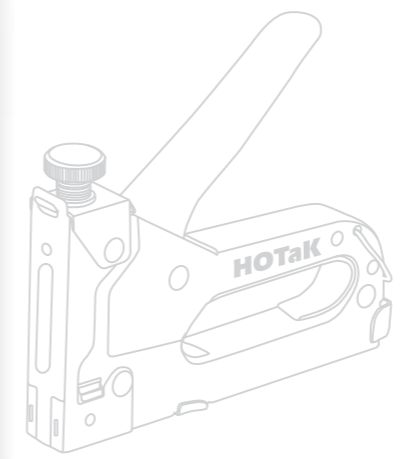

NINGBO LONGYUAN TOOL CO.,LTD

Add: #1zhongxin Load, Jiangshan Town, Ningbo, China 315191

Tel: 86-574-88071038 88452688

Fax: 86-574-88071258 88459055

E-mail: sales@longyuantools.com yjtcl@yj-tools.com

HOTaK

We are located in Ningbo, China. Our sales and R&D team works closely with our customers to turn market needs into innovative products. Our production facilities have embraced lean production system for many years. This lean production system, made famous through Toyota's TPS system, has allowed our manufacturing team to deliver quality products with short lead time and excellent on-time delivery records.

STRENGTH



FIRST-CLASS EQUIPMENT

BEAUTIFUL OFFICE ENVIRONMENT





COMPANY PROFILE

HOTAK TOOLS is one of the leading chinese specialists in the manufacturing of high quality hexagon and torx key wrench, staple gun, precision screwdriver, hobby knife and other high class hand tool set. This is something that everyone in LONGYUAN takes great pride in. the last few years we have developed a large quantity of new quality products. our research and development is a non-stop program to design and manufacture innovative tools for the marketing needs.

We are well on our way to positioning HOTAK brand products for growth in hand tools industry. Quality with a competitive prices structure. we have capability to produce more accuracy and ef quality tools no matter in our brand name HOTAK or your private brand OEM products line. It is our mission to make sure you are 100% guarantee satis, We have published this new booklet as a user friendly guide to show how our products can help to build a more productive job. our current full range of product is represented in combined format for easy of reference. The information supplied here will help you make a more informed.

I wish you the very best and thank you for your interest in product.

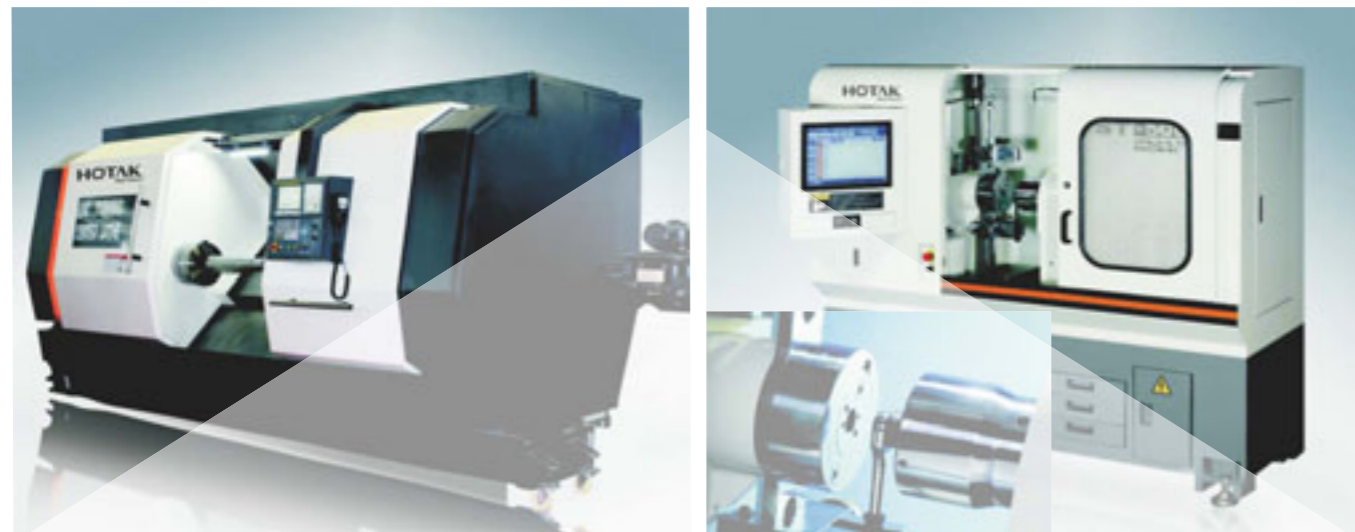

COMPANY MANAGEMENT

R&D:

R&D department is our key part. we have a team that is more than 30 engineers to design and research products special in new products to meet demand from different customers.

SALES:

Sales is the base of enterprise development. we have a professional and enthusiastic sales team to service our customers and let customers feel more convenience.

PRODUCTION:

Production is the guarantee of sales. our production is developing toward specialization, fine direction. We track every order and every item to meet the different demand in craft ship and delivering.

QC:

Quality is the life of enterprise survival. our requests in quality is very strictly. all priodcuts have to be inspected from raw materil to finished goods sothat our products can reach the ANSI & DIN standard.

TEST EXPERIMENT:

There are many professional test machines in our lab to meet customers demand in quality check.

AFTER SERVICE:

After-sales service means order continue. we will deal with every question with more patience and reply customers at first time to let customer feel more sincerity from HOTAQ.

LOGISTICS:

HOTAK tools has strong logistics distribution ability to deliver goods in time with high quality, safety to the hands of customers.



DIRECTORY

TOOL KITS	001-046
STAPLE GUN	047-068
HEX KEY	069-082
PRECISION SCREWDRIVER	083-104
PLIERS AND WRENCHES	105-126
CRAFT & HOBBY KNIVES	127-134
HAND SAW	135-138



TOOL KITS



HOTAK tools are special designed and manufactured with more than 20 years focusing on profession, function, convenience and performance as always.

New products have always been the core and growth points of HOTAK. HOTAK focuses on the research and development of new products to maintain vitality and vigor.

HOTAK

Quality with a competitive prices structure. We have capability to produce more accuracy and efficient quality tools no matter in our brand name HOTAK or your private brand OEM products line. It is our mission to make sure you are 100% guarantee satisfied. We intend to meet and exceed your expectations at any time...now and in the future.

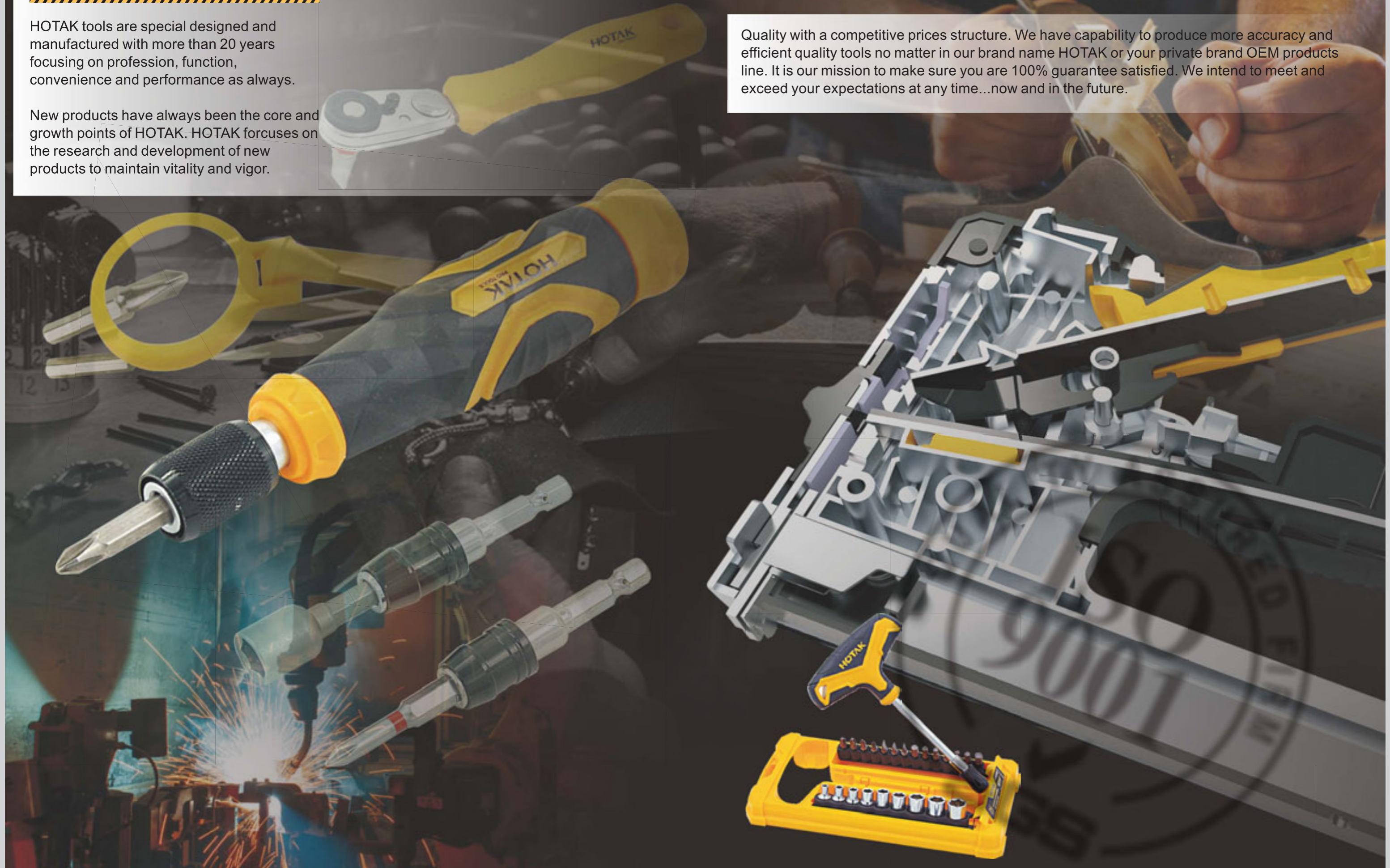



YJTS-3021

18pcs Mini Ratcheting T-handle Set

FEATURES:

- Quick release T shape handle brings convenient use.
- Soft grip handle for more comfortable.
- Very good set for mechanician.

CONTAINS:

- 1pc mini ratchet T-handle.
- 1pc 25mm adaptor.
- 1pc magnetic extension shaft.
- 3pc slotted: 3.0, 5.0, 6.0mm.
- 3pc phillipe: PH1, PH2, PH3.
- 3pc torx: T10, T15, T20
- 6pc sockets: 5, 6, 7, 8, 9, 10mm



YJTS-3020

22pcs Ratchet Wrench & Screwdriver Set



FEATURES:

- Soft grip handle for more comfortable.
- Very good set for mechanician.

CONTAINS:

- 1pc dual color ratchet screwdriver handle.
- 1pc 115mm magnetic extension shaft.
- 4pc slotted: 1.5, 2.0, 2.5, 3.0mm
- 4pc phillipe: PH000, PH00, PH0, PH1
- 7pc torx: T6, T7, T8, T9, T10, T15, T20
- 5pc hex: 1.5, 2.0, 2.5, 3.0, 4.0mm

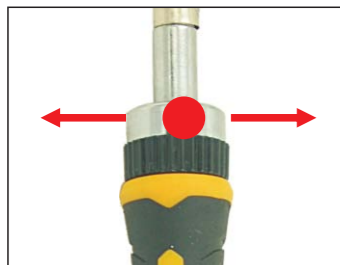

YJTS-3022

23pcs Ratcheting Bit Driver & Socket Set



FEATURES:

- Ratchet handle brings easy use.
- Soft grip handle for more comfortable.
- Very good set for mechanician.

CONTAINS:

- 1pc ratchet screwdriver handle.
- 1pc 25mm adaptor.
- 4pc slotted: 3.0, 4.0, 5.0, 6.0mm.
- 4pc phillipe: PH0, PH1, PH2, PH3.
- 2pc torx: T15, T20.
- 3pc hex: 4.0, 5.0, 6.0mm.
- 2pc pozi: PZ1, PZ2.
- 6pc sockets: 5, 6, 7, 8, 9, 10mm



YJTS-3040

63pcs Ratchet Driver Sets 3 Pack



FEATURES:

- Luxury storage case, small deluxe plastic case.
- Very suitable for general home use of tool.

CONTAINS:

- 3PK small deluxe plastic case

YJTS-2880

36pcs Premium Bit Set



FEATURES:

- Portable carry case.
- Quick release adaptor.
- Contains a selection of bits for a variety of applications.
- Ideal for a wide range of jobs around the home and workshop.

CONTAINS:

- 1pc CR-V 60mm quick change adaptor.
- 7pc phillips: PH1, PH1, PH2, PH2, PH2, PH3, PH3
- 7pc pozi: PZ1, PZ1, PZ2, PZ2, PZ2, PZ3, PZ3
- 7pc slotted: 4.0, 4.5, 5.0, 5.5, 6.0, 6.0, 6.5mm
- 7pc hex: 2.0, 2.5, 3.0, 4.0, 4.0, 5.0, 6.0mm
- 7pc torx: T10, T15, T20, T25, T27, T30, T40



YJTS-3005

36pcs Micro Screwdriver & Precision Knife Set



FEATURES:

- Perfect for scrapbooking, arts and crafts and hobbyists.
- Speed fit connector for quick and easy accessory changes.
- Blades and bits store inside handle.

CONTAINS:

- Perfect kit for scrapbooking enthusiasts, arts and crafts and hobbyists.
- 1/4-in quick change connector accepts all 1/4-in hex bits and accessories.
- (1) 1/4-in hex micro SpeedFit handle with in-handle storage.
- (12) 1-in Phillips/slotted driver bits, bent nose tweezers, small and med 1/4-in hex shank knife heads.
- (20) precision knife blades in a variety of types/sizes, and a blow molded case.
- (20) precision blades: (4) cleaver, (4) hook, (4) #2, (4) #3, and (4) #7.
- Premium bent nose tweezers.



YJTS-3060

13-in-1 Bicycle Repair Tools



FEATURES:

- High quality and multi-function repairing tools.
- Light in weight, convenient to take along with you.
- A necessary partner of your bike.

HOTAK

YJTS-2971

10pcs Precision Screwdriver Set



FEATURES:

- CR-V blades, dual color handle.
- Non-slip sleeves for improved grip and control.
- Needle made of Chrome Vanadium Steel ensure greater hardness, strength and durability.
- Satin chrome plated resists rust and corrosion.
- Ideal for TV repair, instrumentation, cameras, computers, vcrs, telephones etc.
- Surface: Satin finish.

CONTAINS:

- 3pc slotted: 2.0, 2.4, 3.0mm
- 3pc phillipe: PH00, PH0, PH1
- 4pc torx: T6, T7, T8, T10

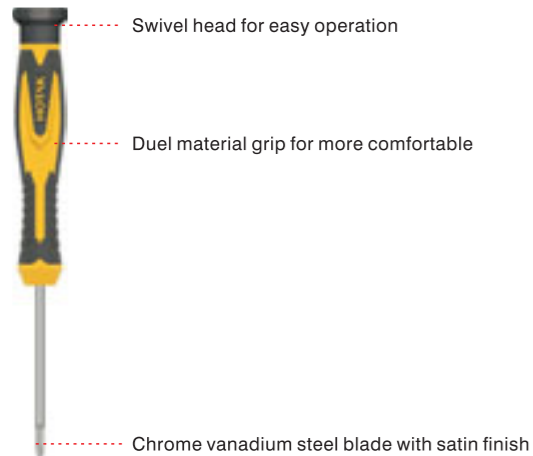

YJPS-6675

6pcs Precision Screwdriver Set



FEATURES:

- CR-V blades, dual color handle.
- Non-slip sleeves for improved grip and control.
- Needle made of Chrome Vanadium Steel ensure greater hardness, strength and durability.
- Satin chrome plated resists rust and corrosion.
- Ideal for TV repair, instrumentation, cameras, computers, vcrs, telephones etc.
- Surface: Satin finish.

CONTAINS:

- 3pc slotted: 1.5, 2.0, 2.5mm
- 3pc phillipe: PH00, PH0, PH1



YJTS-2972

10pcs Precision Screwdriver Set

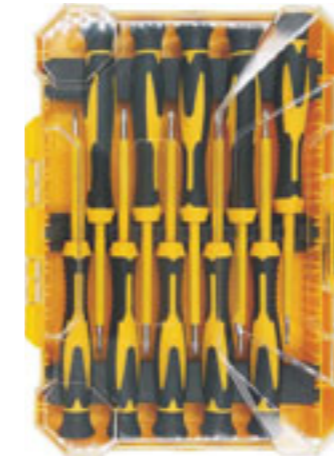

FEATURES:

- CR-V blades, dual color handle.
- Non-slip sleeves for improved grip and control.
- Needle made of Chrome Vanadium Steel ensure greater hardness, strength and durability.
- Satin chrome plated resists rust and corrosion.
- Ideal for TV repair, instrumentation, cameras, computers, vcrs, telephones etc.
- Surface: Satin finish.

CONTAINS:

- 3pc slotted: 2.0, 2.4, 3.0mm
- 3pc phillipe: PH00, PH0, PH1
- 4pc torx: T6, T7, T8, T10

YJPS-6676

6pcs Precision Screwdriver Set



FEATURES:

- CR-V blades, dual color handle.
- Non-slip sleeves for improved grip and control.
- Needle made of Chrome Vanadium Steel ensure greater hardness, strength and durability.
- Satin chrome plated resists rust and corrosion.
- Ideal for TV repair, instrumentation, cameras, computers, vcrs, telephones etc.
- Surface: Satin finish.

CONTAINS:

- 3pc slotted: 1.5, 2.0, 2.5mm
- 3pc phillipe: PH00, PH0, PH1

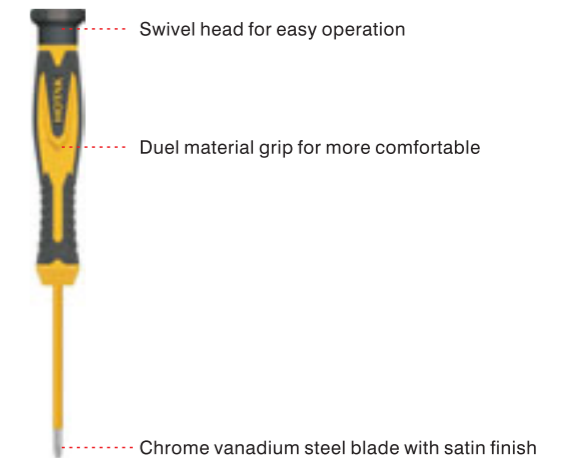

YJTS-2930

31pcs Precision Ratchet Screwdriver Set



FEATURES:

- CR-V screwdriver bits.
- 4-1/2 inch extension bar.
- Stainless steel tweezers with magnifier glass.
- Ratchet screwdriver handle.

CONTAINS:

- 1pc dual color soft grip ratchet screwdriver handle.
- 1pc 3X magnifier/tweezers.
- 1pc 120mm magnetic extension shaft.
- 1pc storage box.
- 27pc precision screwdriver bits:
 - 5pc phillipe: PH000, PH00, PH0, PH1, PH2
 - 5pc slotted: 1.0, 1.5, 2.0, 2.5, 3.0mm
 - 6pc torx: T4, T5, T6, T7, T8, T10
 - 6pc hex: 0.7, 0.9, 1.3, 1.5, 2.0, 3.0mm
 - 2pc Pozi: PZ0, PZ1
 - 1pc tri-wing: 3.0mm
 - 1pc U shape: 2.6mm
 - 1pc Y shape: 3.0mm

ITEM	Packaging	Box/carton	Gw/Nw(kg)	MEAS(cm)
YJTS-2930D	Double blister	6/24	5.5/4.5	51*47*21.5

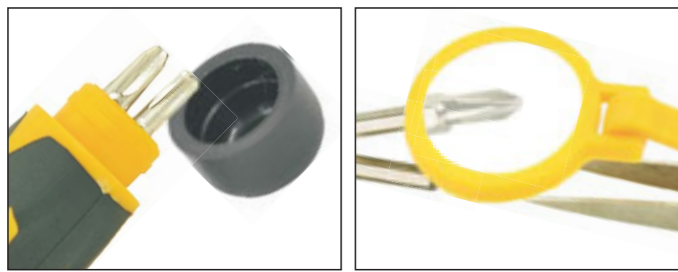

YJTS-2931

31pcs Precision Screwdriver Set



FEATURES:

- CR-V screwdriver bits.
- Luxury storage case, small deluxe plastic case.
- Convenient storage and carrying.
- Very suitable for general home use of tool.

CONTAINS:

- 1pc dual color soft grip screwdriver handle.
- 1pc 3X magnifier.
- 1pc 120mm magnetic extension shaft.
- 1pc storage box.
- 27pc precision screwdriver bits:
 - 5pc phillipe: PH000, PH00, PH0, PH1, PH2
 - 5pc slotted: 1.0, 1.5, 2.0, 2.5, 3.0mm
 - 6pc torx: T4, T5, T6, T7, T8, T10
 - 6pc hex: 0.7, 0.9, 1.3, 1.5, 2.0, 3.0mm
 - 2pc Pozi: PZ0, PZ1
 - 1pc tri-wing: 3.0mm
 - 1pc U shape: 2.6mm
 - 1pc Y shape: 3.0mm

ITEM	Packaging	Box/carton	Gw/Nw(kg)	MEAS(cm)
YJTS-2931D	Double blister	6/24	7.7/6.7	51*47*21.5



YJTS-2932

34pcs Screwdriver Set



FEATURES:

- CR-V screwdriver bits.
- Luxury storage case, small deluxe plastic case.
- Convenient storage and carrying.
- Very suitable for general home use of tool.

CONTAINS:

- 1pc dual color screwdriver handle.
- 1pc 60mm magnetic extension shaft.
- 32pc CR-V bits:
 - 6pc slotted: 2.0, 2.5, 3.0, 4.0, 5.0, 6.0mm
 - 4pc phillips: PH0, PH1, PH2, PH3
 - 4pc Pozi: PZ0, PZ1, PZ2, PZ3
 - 6pc hex: 2.0, 2.5, 3.0, 4.0, 5.0, 6.0mm
 - 7pc torx: T9, T10, T15, T20, T25, T27, T30
 - 2pc square: S1, S2
 - 1pc triangle: 2.0mm
 - 1pc tri-wing: 3.0mm
 - 1pc U shape: 2.6mm

ITEM	Packaging	Box/carton	Gw/Nw(kg)	MEAS(cm)
YJTS-2932D	Double blister	6/24	11.3/10.3	51*47*21.5



YJTS-2933

49pcs Ratchet Screwdriver Set



FEATURES:

- CR-V screwdriver bits.
- Luxury storage case, small deluxe plastic case.
- Convenient storage and carrying.
- Very suitable for general home use of tool.

CONTAINS:

- 1pc dual color ratchet screwdriver handle.
- 48pc CR-V bits:
 - 7pc slotted: 2.0, 2.5, 3.0, 4.0, 5.0, 6.0, 7.0mm
 - 6pc phillips: PH0, PH1, PH2, PH2, PH3, PH3
 - 4pc pozi: PZ0, PZ1, PZ2, PZ3
 - 6pc hex: 2.0, 2.5, 3.0, 4.0, 5.0, 6.0mm
 - 8pc hex: 5/64", 3/32", 7/64", 1/8", 9/64", 5/32", 3/16", 1/4"
 - 12pc torx: T5, T6, T7, T8, T9, T10, T15, T20, T25, T27, T30, T40
 - 2pc square: S1, S2
 - 1pc triangle: 2.0
 - 1pc tri-wing: 3.0mm
 - 1pc U shape: 2.6mm

ITEM	Packaging	Box/carton	Gw/Nw(kg)	MEAS(cm)
YJTS-2933D	Double blister	6/24	13.7/12.7	51*47*21.5



YJCK-4210

29pcs Precision Hobby Knife Set



FEATURES:

- Luxury storage case, small deluxe plastic case.
- Convenient storage and carrying.
- Geat tools for trimming, deburring, chiseling, carning, cutting and other hobby craftwork.

CONTAINS:

- 1pc modelling knives with aluminium handle.
- 1pc tweezers.
- 1pc grindstone.
- 26pc razor sharp blades.

ITEM	Packaging	Box/carton	Gw/Nw(kg)	MEAS(cm)
YJCK-4210D	Double blister	6/24		51*47*21.5



YJTS-2936

42pcs Impact Bits Set-power Tool Accessory



FEATURES:

- S2 or CR-V screwdriver bits.
- Luxury storage case, small deluxe plastic case.
- Convenient storage and carrying.
- Very suitable for general home use of tool.

CONTAINS:

- 1pc 60mm quick change adaptor.
- 3pc 2" nut bit: 1/4", 5/16", 3/8"
- 6pc 2"mm impact bit:
 - 3pc phillips: PH1, PH2, Ph3
 - 1pc square: Sq2
 - 2pc torx: T20, T25
- 32pc S2 standard bit with color band:
 - 5pc phillips: PH1, PH2, PH2, PH2, Ph3
 - 5pc slotted: 3.0, 4.0, 5.0, 5.0, 6.0mm
 - 9pc torx: T10, T15, T20, T20, T25, T25, T27, T30, T40
 - 5pc square: S1, S2, S2, S2, S3
 - 4pc hex: 3.0, 4.0, 5.0, 6.0mm
 - 4pc pozi: PZ1, PZ2, PZ2, PZ3

ITEM	Packaging	Box/carton	Gw/Nw(kg)	MEAS(cm)
YJTS-2936D	Double blister	6/24	13/12	51*47*21.5



YJTS-2780

24pcs T-handle Socket And Screwdriver Set



FEATURES:

- Deluxe heavy duty plastic storage rack.
- Very good set for mechanician.

CONTAINS:

- 1pc T handle
- 1pc driver adaptor
- 3pc torx bits: T20, T25, T30
- 3pc slotted bits: 4.0, 5.0, 6.0mm
- 3pc hex bits: 4.0, 5.0, 6.0mm
- 4pc phillips bits: PH0, PH1, PH2, PH3
- 9pc sockets: 4, 5, 6, 7, 8, 9, 10, 11, 12mm

ITEM	Packaging	Box/carton	Gw/Nw(kg)	MEAS(cm)
YJTS-2780B	Shrink	6/24	12.2/11.2	29.5*23.5*35.5

YJTS-2715

Dual Csrtridge Radial Stripper-2 & 1-Level



FEATURES:

- 2-level coaxial preparation of 5/16in x1/4in(7.9mmx6.4mm).
- Strips outer jacket of unshielded twisted-pair(utp)cables, 1level preparation.
- Designed for high-volume,multiple-type cable preparation environments.
- Two"active" stripping cartidge bays and third "storage" cartridge bay.
- One-piece construction ensures precise stripping and never requires adjustment.
- Cartridges snap in from both sides for left of right-handed operation.
- F-connector "nest" assists with cable insertion.
- Durable high-carbon steel cartridge cutting blades are ground and honed for long life.

ITEM	Packaging	Box/carton	Gw/Nw(kg)	MEAS(cm)
YJTS-2715D	Double blister	6/24	15.6/14.6	47.5*39.5*28.7



YJTS-2790

24pcs Ratchet Screwdriver And Socket Set



FEATURES:

- Deluxe heavy duty plastic storage rack.
- Very good set for mechanician.

CONTAINS:

- 1pc ratchet handle
- 1pc driver adaptor
- 1pc socket adaptor.
- 3pc torx bits: T20, T25, T30
- 3pc slotted bits: 4.0, 5.0, 6.0mm
- 3pc hex bits: 4.0, 5.0, 6.0mm
- 4pc phillips bits: PH0, PH1, PH2, PH3
- 8pc sockets: 5, 6, 7, 8, 9, 10, 11, 12mm

ITEM	Packaging	Box/carton	Gw/Nw(kg)	MEAS(cm)
YJTS-2790B	Shrink	6/24	12.4/11.4	29.5*23.5*35.5



YJTS-2675

5pcs Offset Box-end Wrench Set



FEATURES:

- Carbor steel with chrome plating, bending millimeter wrenches.

CONTAINS:

- 7x8, 9x10, 12x13, 14x15, 19x21mm

ITEM	Packaging	Box/carton	Gw/Nw(kg)	MEAS(cm)
YJTS-2675B	Shrink	6/24	11/10	52.5*29*20

YJTS-2675

5pcs Offset Box-end Wrench Set



FEATURES:

- Carbor steel with chrome plating, bending millimeter wrenches.

CONTAINS:

- 1/4"-5/16", 3/8"-7/16", 1/2"-9/16", 5/8"-3/4", 11/16"-7/8"

ITEM	Packaging	Box/carton	Gw/Nw(kg)	MEAS(cm)
YJTS-2676B	Shrink	6/24	11/10	52.5*29*20



YJTS-2720

25pcs Screwdriver Bit Set



FEATURES:

- Chrome Vanadium Steel for maximum performance.
- The tools are special designed with precise crimping die sets without screw fixing, the operation is easy and convenient.
- Bit hardened for extreme durability, light weight compact.

CONTAINS:

- 1pc T-handle driver
- 6pc 163mm hex bits: 4, 5, 6mm, 5/32, 3/16, 1/4"
- 4pc 115mm bits: 2.5, 3mm, 1/8, 9/64"
- 4pc 50mm bits: PH1, PH2, T10, T15
- 10pc 25mm bits:
 - 5pc torx: T20, T25, T27, T30, T40
 - 5pc slotted: 2.5, 3, 4, 5, 6mm

ITEM	Packaging	Box/carton	Gw/Nw(kg)	MEAS(cm)
YJTS-2720B	Shrink	6/24	15.6/14.6	47.5*39.5*28.7

YJTS-2750

20pcs Ratchet Screwdriver Set With T Handle Driver



FEATURES:

- Chrome Vanadium Steel for maximum performance.
- The tools are special designed with precise crimping die sets without screw fixing, the operation is easy and convenient.
- Bit hardened for extreme durability, light weight compact.

CONTAINS:

- 1pc T-handle driver
- 6pc 163mm hex bits: 4, 5, 6mm, 5/32, 3/16, 1/4"
- 5pc 115mm bits: 2.5, 3, 1/8, 9/64, PH1
- 2pc 150mm bits: 6mm, PH2
- 6pc 50mm bits: PH1, PH2, 6, T15, T20, T25

ITEM	Packaging	Box/carton	Gw/Nw(kg)	MEAS(cm)
YJTS-2750B	Shrink	5/10	11/10	47.5*29*23.5

YJTS-2800

31pcs Bits Set



FEATURES:

- Chrome Vanadium Steel For Maximum Performance
- The operation is easy and convenient, bit hardened for extreme durability, light weight compact.

CONTAINS:

- 1pcs 50mm fast change adaptor
- 30pc 25mm 1/4" CR-V bit:
 - 6pc slotted: 3, 4, 4.5, 5.5, 6, 7mm
 - 4pc phillips: PH0, PH1, PH2, PH3
 - 4pc pozi: PZ0, PZ1, PZ2, PZ3
 - 8pc hexagon: 2, 2.5, 3, 3.5, 4, 5, 5.5, 6mm
 - 8pc torx: T9, T10, T15, T20, T25, T27, T30, T40

ITEM	Packaging	Box/carton	Gw/Nw(kg)	MEAS(cm)
YJTS-2800D	Double blister	6/24	9.4/8.4	51*27.5*26



YJTS-2751

79pcs Precision Tool Set



FEATURES:

- Combination tool set for general home use.

CONTAINS:

- 1pcs aluminium screwdriver handle
- 1pc modelling knives with aluminium handle
- 6pc 110mm bits: PH00, PH0, PH1, T5, T6, SL6
- 4pc phillips bits: PH00, PH0, PH1, PH2
- 6pc slotted bits: 1/16", 5/64", 3/32", 1/8", 9/64", 5/32"
- 8pc torx bits: T4, T5, T6, T7, T8, T10, T15, T20
- 7pc hex bits: 0.035, 0.05, 1/16", 5/64, 3/32", 1/8", 5/32"
- 5pc special bits:
 - triangle: 1/8" triwing 1/8" round bit 0.035"
 - five pointed star bit 5/64" Spanner bit 7/64"
- 39pc blades
- 1pc grindstone
- 1pc magnifier

ITEM	Packaging	Box/carton	Gw/Nw(kg)	MEAS(cm)
YJTS-2751B	Shrink	6/24	16.6/15.6	47.5*29*23.5





YJTS-2360

25pcs Tool Set



- CONTAINS:
- 1pc bottle screwdriver handle
 - 1pc bits Extension bar
 - 1pc sockets Extension bar
 - 1pc H-handle
 - 9pc socket: 5, 6, 7, 8, 9, 10, 11, 12, 13mm
 - 7pc torx: T15, T20, T25, T27, T30, T30, T40
 - 3pc phillips: PH1, PH2, PH3
 - 2pc slotted: 4, 5mm

ITEM	Packaging	Box/carton	Gw/Nw(kg)	MEAS(cm)
YJTS-2360B	Blow case	6/12		40*32.5*17

YJTS-2362

42pcs Drill Bits Set



- CONTAINS:
- 1pc bits extension bar
 - 1pc AD adaptor
 - 1pc chamfering drilling
 - 7pc twist drill: 3, 4, 5, 6, 7, 8, 10mm
 - 9pc socket: 5, 6, 7, 8, 9, 10, 11, 12, 13mm
 - 6pc torx(1/4x25): T15, T20, T25, T27, T30, T40
 - 1pc torx(1/4x50): T30
 - 5pc hex key(1/4x25): H3, H4, H5, H5.5, H6
 - 3pc phillips(1/4x50): PH1, PH2, PH3
 - 6pc slotted(1/4x25): 2.5, 3, 4, 5, 5.5, 6mm
 - 2pc slotted(1/4x50): 4, 5mm

ITEM	Packaging	Box/carton	Gw/Nw(kg)	MEAS(cm)
YJTS-2362B	Blow case	6/12		40*32.5*17

YJTS-2363

39pcs Drill Bits Set



- CONTAINS:
- 1pc AD adaptor
 - 1pc bits extension bar
 - 4pc nut bits: 8, 10, 11, 12mm
 - 1pc chamfering drilling
 - 10pc twist drill: 1.5, 2, 2.5, 3, 3.5, 4, 4.5, 5, 6, 8mm
 - 6pc torx(1/4x25): T15, T20, T25, T27, T30, T40
 - 1pc torx(1/4x50): T30
 - 5pc hex key(1/4x25): H3, H4, H5, H5.5, H6
 - 3pc phillips(1/4x50): PH1, PH2, PH3
 - 6pc slotted(1/4x25): 2.5, 3, 4, 5, 5.5, 6mm
 - 2pc slotted(1/4x50): 4, 5mm

ITEM	Packaging	Box/carton	Gw/Nw(kg)	MEAS(cm)
YJTS-2363B	Blow case	6/12		40*32.5*17

YJTS-2364

40pcs Drill Bits Set



- CONTAINS:
- 1pc quick release head
 - 6pc high socket: 5, 6, 8, 10, 12, 13mm
 - 6pc hex key(1/4x50): H2, H2.5, H3, H4, H5, H6
 - 7pc torx(1/4x25): T15, T20, T25, T27, T30, T30, T40
 - 3pc phillips(1/4x25): PH1, PH2, PH3
 - 2pc slotted(1/4x25): 4, 5mm
 - 2pc extra long double head bit(1/4x100): PH1, PH2
 - 2pc extra long bit(1/4x100): PH1, PH2
 - 5pc long double head bit(1/4x65): SL6, PH1, PH2, PH2, PH2
 - 2pc short double head bit(1/4x45): PH2, PH2
 - 1pc AD adaptor(1/4x65)
 - 3pc drill: 2, 2.5, 3mm

ITEM	Packaging	Box/carton	Gw/Nw(kg)	MEAS(cm)
YJTS-2364B	Blow case	6/12		40*32.5*17



YJTS-2130

33pcs Ratchet Handle & Screwdriver Set

Big case



- FEATURES:
- Deluxe heavy duty plastic case.
 - Very good set for mechanician.
 - Ratchet can be adjusted to the either side freely, easy to use.
 - Cushioned handle for superior grip with convenient 4 bit storage.

- CONTAINS:
- 1pc adapter
 - 1pc multifunctional poliers
 - 1pc mini ratchet handle of ratchet
 - 1pc Multidirectional adjustable ratchet screwdriver handle.
 - 1pc folding hex key set: 1.5, 2, 2.5, 3, 4, 5, 6mm
 - 4pc sockets: 4, 5, 6, 7mm
 - 24pc bits: Slotted-3, 3, 4, 4, 5, 5, 5, 6, 6, 6, 6, 7, 7mm
Phillips-#0, #0, #1, #1, #1, #2, #2, #2, #2, #3, #3

ITEM	Packaging	Box/carton	Gw/Nw(kg)	MEAS(cm)
YJTS-2130B	Bulk	12	13.5/12.5	45*28.5*25.5



YJTS-2141

26pcs Ratchet Handle & Screwdriver Set

Middle case



FEATURES:

- Deluxe heavy duty plastic case.
- Luxury storage case.
- Very good set for mechanician.

CONTAINS:

- 1pc 1/4 in. soft grip stubby ratchet handle.
- 1pc 25mm 1/4 in. Adaptor.
- 1pc 53mm 1/4 in. Adaptor.
- 10pc 1/4 in. CR-V sockets: 4, 5, 6, 7, 8, 9, 10, 11, 12, 13mm.
- 12pc 25mm CR-V bits: Phillips-PH0, PH1, PH2, PH3.
Torx-T15, T20, T25, T30.
Slotted-3, 4, 5, 6mm.
- 1pc multidirectional adjustable ratchet screwdriver handle.

ITEM	Packaging	Box/carton	Gw/Nw(kg)	MEAS(cm)
YJTS-2141B	Bulk	6/12	10/9	50*28*20.5

YJTS-2212

26pcs Socket Wrench & Screwdriver Set

Middle case



FEATURES:

- Deluxe heavy duty plastic case.
- Luxury storage case.
- Very good set for mechanician.

CONTAINS:

- 1pc 1/4 in. soft grip stubby ratchet handle.
- 1pc 25mm 1/4 in. Adaptor.
- 1pc 53mm 1/4 in. Adaptor.
- 10pc 1/4 in. CR-V sockets: 4, 5, 6, 7, 8, 9, 10, 11, 12, 13mm.
- 12pc 25mm CR-V bits: Phillips-PH0, PH1, PH2, PH3.
Torx-T15, T20, T25, T30.
Slotted-3, 4, 5, 6mm.
- 1pc multidirectional adjustable ratchet screwdriver handle.

ITEM	Packaging	Box/carton	Gw/Nw(kg)	MEAS(cm)
YJTS-2212B	Bulk	6/12	11/10	50*28*20.5



YJTS-2210

24pcs Socket Wrench & Screwdriver Set

Middle case



FEATURES:

- Deluxe heavy duty plastic case.
- Luxury storage case.
- Very good set for mechanician.

CONTAINS:

- 1pc 1/4" soft grip stubby ratchet handle
- 1pc 1/4" ratchet and bit driver, simple but useful.
- 1pc 25mm 1/4" adapter.
- 1pc 120mm CR-V and zinc alloy
- 1pc black finish extension shaft.
- 8pc CR-V 6150 sanding finish bits:
4pc PH: #1, #2, #3
2pc torx: T15, T20
2pc pozi: PZ1, PZ2
- 2pc 1/4" 50mm CR-V sanding finish bits: PH1, PZ2
- 9pc 1/4" satin finish sockets: 4, 5, 6, 7, 8, 9, 10, 11, 12mm.

ITEM	Packaging	Box/carton	Gw/Nw(kg)	MEAS(cm)
YJTS-2210B	Bulk	6/12	11/10	50*28*20.5



YJTS-2211

Self-tapping Screws & Plastic Tox & Drill

Middle case



FEATURES:

- Deluxe heavy duty plastic case.
- Luxury storage case.
- Very good set for mechanician.

CONTAINS:

- 2pc phillips: PH1, PH2
- 2pc Drill
- 50pc plastic tox
- 20pc self-tapping screws(4X30mm)
- 20pc self-tapping screws(5X40mm)

ITEM	Packaging	Box/carton	Gw/Nw(kg)	MEAS(cm)
YJTS-2211B	Bulk	6/12	7/6	50*28*20.5

YJTS-2222

30pcs Socket Wrench & Screwdriver Set

Middle case



FEATURES:

- Deluxe heavy duty plastic case.
- Luxury storage case.
- Very good set for mechanician.

CONTAINS:

- 1pc mini ratchet handle
- 1pc 1/4" ratchet and bit driver, simple but useful.
- 1pc 25mm 1/4" adapter.
- 1pc 50mm 1/4 in./5/32 in. convert adaptor
- 1pc T-handle
- 16pc CR-V 6150 bits:
4pc slotted: SL3, SL4, SL4.5, SL5
4pc torx: T15, T20, T25, T27
4pc pozi: PZ0, PZ1, PZ2, Pz3
4pc hex: 2.5, 3.0, 3.5, 4.0mm
- 9pc 1/4" satin finish sockets: 4, 5, 6, 7, 8, 9, 10, 12, 13mm

ITEM	Packaging	Box/carton	Gw/Nw(kg)	MEAS(cm)
YJTS-2222B	Bulk	6/12	9.5/8.5	50*28*20.5



YJTS-2223

21pcs Socket Wrench & Screwdriver Set

Middle case



FEATURES:

- Deluxe heavy duty plastic case.
- Luxury storage case.
- Very good set for mechanician.

CONTAINS:

- 1pc 1/4" ratchet and bit driver, simple but useful.
- 1pc 50mm 1/4 in./5/32 in. convert adaptor
- 1pc hex key set
- 1pc multifunctional pliers
- 1pc T-handle
- 16pc CR-V 6150 bits:
4pc slotted: SL3, SL4, SL4.5, SL5
4pc torx: T15, T20, T25, T27
4pc pozi: PZ0, PZ1, PZ2, PZ3
4pc hex: 2.5, 3.0, 3.5, 4.0mm

ITEM	Packaging	Box/carton	Gw/Nw(kg)	MEAS(cm)
YJTS-2223B	Bulk	6/12	9/8	50*28*20.5



YJTS-2151

20pcs Professional Bits Set



FEATURES:

- Luxury storage case.
- Very good set for mechanician.
- Small deluxe plastic case.

CONTAINS:

- 1pc adapter
- 10pc 25mm bits:
 - 2pc slotted: 4, 5mm
 - 2pc phillips: PH1, PH2
 - 2pc torx: T15, T20
 - 2pc pozi bits: PZ1, PZ2
 - 2pc hex: 4, 5mm
- 6pc 75mm bits: 2xPH1, 2xPH2, S1 & S2
- 3pc socket bits: 1/4", 5/16", 3/8"

ITEM	Packaging	Box/carton	Gw/Nw(kg)	MEAS(cm)
YJTS-2151B	Bulk	8/32	13/12	41.5*30.5*21

YJTS-2153

26pcs Professional Bits Set



FEATURES:

- Luxury storage case.
- Very good set for mechanician.
- Small deluxe plastic case.

CONTAINS:

- 1pc socket bit
- 5pc 50mm bits:
 - 2pc phillips: PH2 & PH3
 - 1pc torx: T30;
 - 2pc square bits: S2 & S3
- 20pc 25mm bits:
 - 4pc slotted: 2x4mm & 2x5mm
 - 4pc phillips: 2xPH1 & 2xPH2
 - 4pc torx: 2xT15 & 2xT20;
 - 4pc pozi bits: 2xPZ1 & 2xPZ2
 - 4pc hex: 2x4mm & 2x5mm

ITEM	Packaging	Box/carton	Gw/Nw(kg)	MEAS(cm)
YJTS-2153B	Bulk	8/32	10.6/9.6	41.5*30.5*21



YJTS-2158

43pcs Professional Bits Set



FEATURES:

- Luxury storage case.
- Very good set for mechanician.
- Small deluxe plastic case.

CONTAINS:

- 1pc 50mm fast change adaptor
- 1pc 25m 1/4 in. adpater.
- 41pc 25mm 1/4 in. CR-V sanding bits:
 - 10pc phillips: 3xPH1, 5xPH2, 2xPh3
 - 6pc pozi: PZ0, PZ1, 3xPZ2, PZ3
 - 5pc hex: 2, 3, 4, 5, 6mm
 - 10pc torx: T10, T15, 2xT20, 2xT25, T27, 2xT30, T40
 - 10pc slotted: 2x3, 2x4, 2x5, 2x6, 2x7mm

ITEM	Packaging	Box/carton	Gw/Nw(kg)	MEAS(cm)
YJTS-2158B	Bulk	8/32	13.3/12.3	41.5*30.5*21



YJTS-2155

30pcs Screwdriver & Socket Set



FEATURES:

- Luxury storage case.
- Very good set for mechanician.
- Small deluxe plastic case.

CONTAINS:

- 1pc 1/4 in. double-ends zinc alloy and CR-V 6150 handle
- 1pc 50mm 1/4 in. magnetic extension bar.
- 1pc 25mm 1/4 in. socket adaptor.
- 6pc 1/4 in. Sockets: 5, 6, 7, 8, 9, 10mm
- 21pc 1/4" CR-V sanding finish bits:
 - 4pc slotted: 3, 4, 5, 6mm
 - 3pc phillips: PH1, PH2, PH3
 - 3pc pozi: PZ1, PZ2, PZ3
 - 4pc hexgon: 3, 4, 5, 6mm
 - 7pc torx: T10, T15, T20, T25, T27, T30, T40

ITEM	Packaging	Box/carton	Gw/Nw(kg)	MEAS(cm)
YJTS-2155B	Bulk	8/32	13.3/12.3	41.5*30.5*21



YJTS-2159

28pcs Ratchet Screwdriver Set



FEATURES:

- Luxury storage case.
- Very good set for mechanician.
- Small deluxe plastic case.

CONTAINS:

- 1pc 25mm 1/4 in. CR-V sanding finish adpater.
- 1pc ratchet screwdriver
- 27pc 25mm 1/4 in. CR-V sanding finish bits:
 - 4pc slotted: 3, 4, 5, 6mm
 - 5pc torx: T10, T15, T20, T25, T30
 - 4pc torx with hole (tamper proof): T10, T15, T20, T25
 - 4pc pozi: PZ0, PZ1, PZ2, PZ3
 - 4pc phillips: PH0, PH1, PH2, PH3
 - 6pc hexagon: 2, 2.5, 3, 4, 5, 6mm

ITEM	Packaging	Box/carton	Gw/Nw(kg)	MEAS(cm)
YJTS-2159B	Bulk	8/32	12.2/11.2	41.5*30.5*21



YJTS-2311

26pcs Ratchet Screwdriver Set



FEATURES:

- Luxury storage case.
- Very good set for mechanician.
- Small deluxe plastic case.
- Transparent lid.

CONTAINS:

- 1pc extention bar
- 1pc ratchet handle
- 1pc 1/4 socket adapter
- 4pc torx: T10 T15, T20, T30
- 2pc slotted: 3.0, 4.0mm
- 4pc pozi: PZ0, PZ1, PZ2, PZ3
- 4pc phillips: PH0, PH1, PH2, PH3
- 9pc sockets: 4, 5, 6, 7, 8, 9, 10, 12, 13mm

ITEM	Packaging	Box/carton	Gw/Nw(kg)	MEAS(cm)
YJTS-2311B	Bulk	6/24	13.6/12.6	41.5*22*26.5

YJPS-6210

17pcs Precision Aluminum Screwdriver Set



FEATURES:

- Luxury storage case.
- Very good set for mechanician.
- Small deluxe plastic case.
- Transparent lid.

CONTAINS:

- 5pc phillips: PH000, PH00, PH0, PH1, PH2
- 4pc slotted: SL2.0, SL2.5, SL3.0, SL4.0
- 8pc torx internal: T4, T5, T6, T7, T8, T9, T10, T15
- 1pc aluminum handle

ITEM	Packaging	Box/carton	Gw/Nw(kg)	MEAS(cm)
YJPS-6210B	Bulk	12/48	8/7	35.5*27.5*25



YJTS-2312

23pcs Precision Screwdriver Bit Set



FEATURES:

- Luxury storage case.
- Very good set for mechanician.
- Small deluxe plastic case.
- Transparent lid.

CONTAINS:

- 1pc screwdriver handle with speed fit
- 1pc soft extension bar
- 4pc phillips: PH00, PH0, PH1, PH2
- 8pc torx: T4, T5, T6, T7, T8, T9, T10, T15
- 3pc slotted: 2.0, 3.0, 4.0mm
- 6pc socket bits: 2.5, 3.0, 3.5, 4.0, 4.5, 5.0mm

ITEM	Packaging	Box/carton	Gw/Nw(kg)	MEAS(cm)
YJTS-2312B	Bulk	6/24	7.5/6.5	41.5*22*26.5



YJTS-2310

15pcs Smart Phone Repair Kit



FEATURES:

- Luxury storage case.
- Very good set for mechanician.
- Small deluxe plastic case.
- Transparent lid.

CONTAINS:

- 1pc alumiium handle screwdriver
- 1pc suction cup
- 2pc mini pry bar
- 1pc SIM card tray opener
- 10pc precision bits:
 - 1pc triangle: 2.0mm
 - 1pc five pointed star bit: 0.8mm
 - 2pc phillips: PH000, PH00
 - 1pc slotted: 1.2mm
 - 5pc torx: T4, T5, T6, T8, T10

ITEM	Packaging	Box/carton	Gw/Nw(kg)	MEAS(cm)
YJTS-2310B	Bulk	6/24	7.4/6.4	41.5*22*26.5

YJTS-2315

17pcs Smart Phone Repair Kit



FEATURES:

- Luxury storage case.
- Very good set for mechanician.
- Small deluxe plastic case.
- Transparent lid.

CONTAINS:

- 1pc alumiium handle screwdriver
- 1pc suction cup
- 2pc mini pry bar
- 1pc SIM card tray opener
- 12pc precision bits:
 - 1pc triangle: 2.0mm
 - 2pc five pointed star bit: 0.8, 2.0mm
 - 2pc phillips: PH000, PH00
 - 1pc slotted: 1.2mm
 - 6pc torx: T4, T5, T6, T7, T8, T10

ITEM	Packaging	Box/carton	Gw/Nw(kg)	MEAS(cm)
YJTS-2315B	Bulk	12/48	8/7	35.5*27.5*25



YJTS-2620

4-in-1 Hook & Pick Set



FEATURES:

- Use to pull o-ring, seals, cotter pins, and brushes.
- Includes 3.5 in aluminum handle and the following picks: o-ring, 90°, straight, and hool.



YJPS-6201

28pcs Screwdriver Set With Aluminum handle



- FEATURES:**
- Luxury storage case.
 - Very good set for mechanician.
 - Small deluxe plastic case.
 - Transparent lid.

- CONTAINS:**
- 4pc phillips: PH000, PH00, PH0, PH1
 - 5pc slotted: 0.7, 1.0, 1.2, 1.5, 1.8mm
 - 4pc PZ: PZ000, PZ00, PZ0, PZ1
 - 5pc hex key: 0.7, 0.9, 1.3, 1.5, 2.0mm
 - 5pc torx internal: T4, T5, T6, T7, T8
 - 5pc special bits:
 - Triangle: 1/8"
 - Triwing 1/8"
 - Five pointed star bit 5/64"
 - Spanner bit 7/64"
 - Round bit 0.035"
 - 1pc aluminum handle

ITEM	Packaging	Box/carton	Gw/Nw(kg)	MEAS(cm)
YJPS-6201B	Bulk	12/48	10/9	35.5*27.5*25



YJCK-4140

13pcs Precision Knife Set



- FEATURES:**
- Luxury storage case.
 - Very good set for mechanician.
 - Small deluxe plastic case.
 - Transparent lid.
 - Great for model making arts and crafts or any hobby for cutting paper, plastic, metal and etc.
 - Interchangeable blades for different rate of.

- CONTAINS:**
- 13pc razor sharp blades
 - 1pc aluminum handle

ITEM	Packaging	Box/carton	Gw/Nw(kg)	MEAS(cm)
YJCK-4140B	Bulk	12/48	6.4/5.4	35.5*27.5*25

YJTS-2265

2PK Precision Tool Sets Bonus Magnifier



- FEATURES:**
- Luxury storage case.
 - Very good set for mechanician.
 - Small deluxe plastic case.
 - Transparent lid.

- CONTAINS:**
- 28pc screwdriver set with aluminum handle
 - 13pc hobby knife with aluminum handle
 - 1pc magnifier.

ITEM	Packaging	Box/carton	Gw/Nw(kg)	MEAS(cm)
YJTS-2265D	Double blister	6/24	11/10	48.5*27*42.5



YJPS-6050

18pcs Precision Ratchet Screwdriver Bits Set



- FEATURES:**
- Deluxe plastic case.
 - Bits are made of chrome vanadium steel to exact precision.

- CONTAINS:**
- 1pc dual-color screwdriver handle
 - 1pc magnetic extension bar
 - 16pc CR-V bits :
 - 8pc torx: T4, T5, T6, T7, T8, T9, T10, T15
 - 4pc metric: 2.0, 2.5, 3.0, 4.0mm
 - 4pc phillips: PH00, PH0, PH1, PH2

ITEM	Packaging	Box/carton	Gw/Nw(kg)	MEAS(cm)
YJPS-6048B	Bulk	6/24	11/10	40.5*22*28

YJPS-6048

38pcs Ratcheting Screwdriver Set



- FEATURES:**
- Deluxe plastic case.
 - Bits are made of chrome vanadium steel to exact precision.

- CONTAINS:**
- 1pc 2.5mm adaptor
 - 1pc 1/4" dual-color ratchet handle
 - 36pc precision screwdriver CR-V bits :
 - 4pc torx with hole: T10, T15, T20, T30
 - 6pc torx: T10, T15, T20, T25, T30, T40
 - 7pc hex key: 2.0, 2.5, 3.0, 4.0, 5.0, 5.5, 6.0, 4.0, 5.0mm
 - 7pc phillips: PH0, PH1, PH2, PH3, PH1, PH2, PH0
 - 6pc slotted: 4.0, 5.0, 5.5, 6mm
 - 4pc pozi: PZ0, PZ1, PZ1, PZ3
 - 2pc square: S1, S2

ITEM	Packaging	Box/carton	Gw/Nw(kg)	MEAS(cm)
YJPS-6050B	Bulk	6/24	6.8/5.8	40.5*22*28

YJTS-2018

23pcs Ratchet Wrench Set



- FEATURES:**
- Deluxe plastic case.
 - Bits are made of chrome vanadium steel to exact precision.

- CONTAINS:**
- 1pc dual-color handle Wrench
 - 1pc magnetic extension bar.
 - 9pc socket: 4, 5, 6, 7, 8, 9, 10, 11, 12mm
 - 12pc CR-V bits:
 - 4pc hex bits: 3, 4, 5, 6mm
 - 4pc torx bits: T15, T20, T25, T30
 - 2pc phillips bits: PH1, PH2
 - 2pc slotted bits: 4, 5mm

ITEM	Packaging	Box/carton	Gw/Nw(kg)	MEAS(cm)
YJTS-2018B	Bulk	6/24	10.6/9.6	40.5*22*28

YJCK-472

8pcs Precision Hobby Knife Set



- FEATURES:**
- Deluxe plastic case
 - Great for model making arts and crafts or any hobby for cutting paper.

- CONTAINS:**
- 6pc medium and heavy duty blades
 - 1pc aluminium light duty blade holder with SK5 #11 blade
 - 1pc aluminium heavy duty blade holder with SK5 #20 blade

ITEM	Packaging	Box/carton	Gw/Nw(kg)	MEAS(cm)
YJCK-472B	Bulk	6/24	5/4	40.5*22*28





YJPS-6021

36pcs Precision Screwdriver Set



FEATURES:

- Deluxe plastic case.
- Bits are made of chrome vanadium steel to exact precision..

CONTAINS:

- 1pc Dual-color Screwdriver Handle
- 1pc Magnetic Extension Bar
- 34pc CR-V bits:
 - 9pc torx: T4, T5, T6, T7, T8, T9, T10, T15, T20
 - 7pc tex: 0.035", 0.05", 1/16", 5/64", 3/32", 1/8", 5/32"
 - 6pc slotted: 1/16", 5/64", 3/32", 1/8", 9/64", 5/32"
 - 5pc phillips: PH000, PH00, PH0, PH1, PH2
 - 2pc pozi: PZ0, PZ1
 - 1pc round: 1.0mm
 - 1pc star: 2.0mm
 - 1pc triangle: 3.0mm
 - 1pc tri wing: 3.0mm
 - 1pc spanner slotted: 2.6mm

ITEM	Packaging	Box/carton	Gw/Nw(kg)	MEAS(cm)
YJPS-6021B	Bulk	6/24	9.8/8.8	53.5*27*26.5



YJTS-2031

29pcs Tool Set



FEATURES:

- Deluxe plastic case.
- Bits are made of chrome vanadium steel to exact precision.
- T shaped handle brings convenient use.
- Chrome plated sockets to resist rust.

CONTAINS:

- 1pc T-handle bit holder
- 1pc 50mm socket adaptor
- 1pc 25mm adaptor.
- 1pc rubberized screwdriver handle.
- 9pc 1/4"Dr. sockets: 4, 5, 6, 7, 8, 9, 10, 11, 12mm
- 16pc screwdriver bits:
 - 4pc phillips: #0, #1, #2, #3
 - 5pc torx: T10, T15, T20, T25, T30
 - 3pc slotted: 4, 5, 6mm
 - 4pc pozi: #0, #1, #2, #3

ITEM	Packaging	Box/carton	Gw/Nw(kg)	MEAS(cm)
YJTS-2031B	Bulk	6/24	16/15	53.5*27*26.5

YJCK-471

14pcs Precision Hobby Knife Set



FEATURES:

- Deluxe plastic case.
- Great for model making arts and crafts or any hobby for cutting paper. Heavy duty rubber grip knife handles provides a secure hold during use.

CONTAINS:

- 12pc SK5 medium and heavy duty blades
- 1pc rubber coated blade holder with 1pc SK5 #11 blade
- 1pc heavy duty blade holder with 1pc SK5 blade

ITEM	Packaging	Box/carton	Gw/Nw(kg)	MEAS(cm)
YJCK-471B	Bulk	6/24	7.5/6.5	53.5*27*26.5

YJPS-6046

12pcs Precision Tool set



FEATURES:

- Deluxe plastic case.
- CR-V blades with satin finish.
- For precision work on electronics, hobbies, eye glasses models trains & other small items.
- Blades are made of chrome vanadium steel to exact precision.

CONTAINS:

- 3pc phillips screwdrivers: PH00, PH0, PH1
- 3pc slotted screwdrivers: 1.4mm, 1.8mm, 2.4mm
- 2pc Hex screwdrivers: 2mm, 2.5mm
- 1pc mini diagonal Pliers
- 1pc mini long nose Pliers
- 1pc magnifier
- 1pc tweezer

ITEM	Packaging	Box/carton	Gw/Nw(kg)	MEAS(cm)
YJPS-6046B	Bulk	6/12	7.7/6.7	40.5*29.3*25



YJCK-470

35pcs Deluxe Precision Hobby Knife Set



FEATURES:

- Deluxe plastic case
- Great for model making arts and crafts or any hobby for cutting paper.
- Heavy duty rubber grip knife handles provides a secure hold during use.

CONTAINS:

- 30pc medium and heavy duty blades
- 1pc pair of tweezers
- 1pc plastic caliper
- 1pc precision jewelers screwdriver
- 1pc rubber coated blades holder with 1pc #11 blade
- 1pc deluxe grip blade holder with 1pc carving blade

ITEM	Packaging	Box/carton	Gw/Nw(kg)	MEAS(cm)
YJCK-470B	Bulk	6/12	6.6/5.6	40.5*29.3*25



YJPS-6121

20pcs Ratchet Screwdriver & Sockets Set



FEATURES:

- Deluxe aluminium case, chrome plated to resist rust
- Bits of high quality Chrome-Vanadium Steel
- Good helping hand for repairing easily.

CONTAINS:

- 5pc sockets: 6, 7, 8, 10, 13mm
- 2pc phillips: PH1, PH2
- 2pc pozi: PZ1, PZ2,
- 2pc slotted: 4.0, 5.0mm
- 1pc 25mm adaptor
- 1pc mini ratchet handle
- 7pc torx: T10, T15, T20, T25, T27, T30, T40

ITEM	Packaging	Box/carton	Gw/Nw(kg)	MEAS(cm)
YJPS-6121D	Double blister	6/36	10.6/9.6	43*44.7*28.5

YJPS-6123

27pcs Stubby Ratchet Screwdriver & Sockets Set



FEATURES:

- Deluxe aluminium case, chrome plated to resist rust
- Bits of high quality Chrome-Vanadium Steel
- Good helping hand for repairing easily.

CONTAINS:

- 1pc 1/4" adaptor
- 1pc power pole
- 1pc mini stubby ratchet
- 5pc sockets: 5.5, 7, 8, 10, 12mm
- 19pc bits: 5pc Hex: H2.5, H3.0, H4.0, H5.0, H6.0
- 7pc torx: T10, T15, T20, T25, T27, T30, T40
- 4pc phillips: PH0, PH1, PH2, PH3
- 3pc slotted: SL3.0, SL4.0, SL6.0

ITEM	Packaging	Box/carton	Gw/Nw(kg)	MEAS(cm)
YJPS-6123D	Double blister	6/36	13.7/12.7	43*44.7*28.5



YJPS-6125

43pcs Precision Screwdriver Bits Set



FEATURES:

- Deluxe aluminium case, chrome plated to resist rust
- Bits of high quality Chrome-Vanadium Steel
- Good helping hand for repairing easily.

CONTAINS:

- 1pc aluminium bit handle
- 42pc bits:
 - 1pc triangle: 3.0mm
 - 1pc triwing: 3.0mm
 - 1pc round: 1.0mm
 - 1pc spanner
 - 7pc hex: 0.7, 0.9, 1.3, 1.5, 2.0, 2.5, 3.0
 - 5pc torx with hole: T7, T8, T9, T10, T15
 - 8pc torx without hole: T4, T5, T6, T7, T8, T9, T10, T15
 - 5pc phillips: PH000, PH00, PH0, PH1
 - 4pc pozi: PZ000, PZ00, PZ0, PZ1
 - 9pc slotted: 1.0, 1.2, 1.5, 1.8, 2.0, 2.5, 3.0, 3.5, 4.0

ITEM	Packaging	Box/carton	Gw/Nw(kg)	MEAS(cm)
YJPS-6125D	Double blister	6/36	13/12	43*44.7*28.5

YJPS-6124

36pcs Screwdriver Bits Set



FEATURES:

- Deluxe aluminium case, chrome plated to resist rust
- Bits of high quality Chrome-Vanadium Steel
- Good helping hand for repairing easily.

CONTAINS:

- 1pc stubby adaptor
- 1pc 1/4" adaptor
- 34pc bits:
 - 4pc hex: H3, H4, H5, H6
 - 6pc torx with port: TP10, TP15, TP20, TP25, TP27, TP30
 - 12pc torx: T10, T15, T20, T25, T27, T27, T30, T30, T40, T40
 - 6pc pozi: PZ1, PZ1, PZ2, PZ2, PZ3, PZ3
 - 3pc phillips: PH1, PH2, PH3
 - 3pc slotted: SL4.0, SL4.5, SL5.5,

ITEM	Packaging	Box/carton	Gw/Nw(kg)	MEAS(cm)
YJPS-6124D	Double blister	6/36	16.3/15.3	43*44.7*28.5

YJPS-6122

21pcs Hobby Tool Set



FEATURES:

- Deluxe aluminium case, chrome plated to resist rust
- Good helping hand for repairing easily.

CONTAINS:

- 1pc adaptor
- 1pc measure tape
- 1pc pocket hobby knife
- 1pc plastic level ruler
- 2pc precision screwdriver: SL2.0mm and PH00
- 4pc sockets: 7, 8, 9, 10mm
- 10pc bits: 4pc torx: T10, T15, T20, T25
- 2pc phillips: PH1, PH2
- 2pc pozi: PZ1, PZ2
- 2pc slotted: SL5, SL6

ITEM	Packaging	Box/carton	Gw/Nw(kg)	MEAS(cm)
YJPS-6122D	Double blister	6/36	13.7/12.7	43*44.7*28.5

YJTS-2921

Zip Phillips & slotted Driver



FEATURES:

- Zipper attachment for everyday carry.
- Clip for quick removal 2 flat Head drivers length: 54.6mm 2 phillips head drivers.
- At home, use it to tighten a pair of glasses or an escaping frying pan handle.
- At work, stealthily fix that annoying bathroom door.

YJTS-2922

Zip Hex Driver



FEATURES:

- Clip for quick removal Length: 2.1 inches.
- Ball detent locking mechanism.
- Featuring five of the most commonly used metric allen.
- 5 Metric Allen wrenches
- 2.5mm, 3.0mm, 4.0mm, 5.0mm, 6.0mm

YJTS-2923

Zip Blade



FEATURES:

- Daily Carry is all about tools that integrate easily into your lifestyle.
- The Zip Blade is designed to do just that.
- This light but tough fine edge utility blade includes a fob for attachment to the zipper of a backpack, seat bag, or coat.
- The quick-release clip allows for the tool to be easily removed and reattached, and the blade features a frame lock for safety.
- Having this tool on your pack will get you out of more jams that you'll be able to count, and even when it's not in use it just looks damn good.

YJTS-2924

Zip Light And Bottle Opener



FEATURES:

- Featuring a bright, compact LED light and a handy little bottle opener, attach this tool to the zipper of your jacket pocket or your shoulder bag and be ready to take on whatever comes your way.
- Opening your car door in a dark parking lot, finding your way into your tent at the end of the night, helping your friends open a couple cold ones.
- With the Zip Light+ by your side, consider these problems solved.



YJPS-6101

45pcs Ratcheting T-driver Set



- FEATURES:**
- Deluxe plastic case.
 - For the handyman in your household.
 - This torque-driver set has an ergonomic handle that allows for entry into difficult-to-reach areas.
 - CR-V bits and chrome plated sockets for long life time use.

- CONTAINS:**
- 1pc dual-color ratchet & screwdriver T handle
 - 1pc 25mm adaptor
 - 1pc extension bar
 - 24pc 1/4 screwdriver bits:
 - 4pc phillips: PH0, PH1, PH2, PH3
 - 4pc pozi: PZ0, PZ1, PZ2, PZ3
 - 6pc torx: T10, T15, T20, T25, T30, T40
 - 2pc square: S1, S2
 - 4pc hex: H3, H4, H5, H6
 - 4pc slotted: SL3, SL4, SL5, SL6
 - 18pc 1/4 sockets:
 - 9pc metric: 4, 5, 5.5, 6, 7, 8, 9, 10, 12mm
 - 9pc SAE: 5/32, 3/16, 7/32, 1/4, 9/32, 5/16, 11/32, 3/8, 1/2"

ITEM	Packaging	Box/carton	Gw/Nw(kg)	MEAS(cm)
YJPS-6101B	Bulk	6/12	20.5/19.5	43.5*21.5*30

YJPS-6102

37pcs Ratcheting T-driver Set



- FEATURES:**
- Deluxe plastic case.
 - For the handyman in your household.
 - This torque-driver set has an ergonomic handle that allows for entry into difficult-to-reach areas.
 - CR-V bits and chrome plated sockets for long life time use.

- CONTAINS:**
- 1pc dual-color ratchet & screwdriver T handle
 - 1pc dual-color screwdriver handle
 - 1pc 25mm adaptor
 - 1pc extension bar
 - 12pc 5/32 screwdriver bits:
 - 4pc phillips: PH00, PH0, PH1, PH2
 - 4pc torx: T8, T9, T10, T15
 - 4pc slotted: SL2, SL2.5, SL3, SL4
 - 12pc 1/4 screwdriver bits:
 - 4pc phillips: PH0, PH1, PH2, PH3
 - 4pc torx: T20, T25, T30, T40
 - 4pc slotted: SL3, SL4, SL5, SL6
 - 9pc 1/4 sockets: 4, 5, 5.5, 6, 7, 8, 9, 10, 12mm

ITEM	Packaging	Box/carton	Gw/Nw(kg)	MEAS(cm)
YJPS-6102B	Bulk	6/12	19/18	43.5*21.5*30

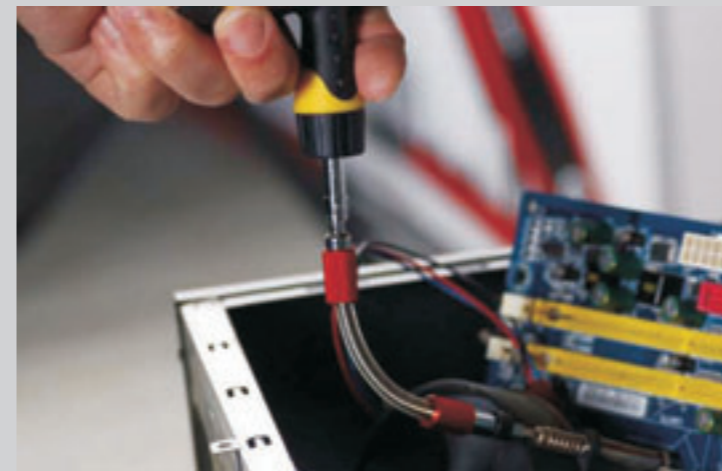

YJPS-6103

39pcs Ratcheting T-driver Set



- FEATURES:**
- Deluxe plastic case.
 - For the handyman in your household.
 - This torque-driver set has an ergonomic handle that allows for entry into difficult-to-reach areas.
 - CR-V bits and chrome plated sockets for long life time use.

- CONTAINS:**
- 1pc dual-color ratchet & screwdriver T handle
 - 1pc 25mm adaptor
 - 1pc bit socket
 - 1pc ratchet head
 - 1pc 1/4" extension shaft
 - 16pc 1/4" screwdriver bits:
 - 4pc phillips: PH00, PH0, PH1, PH2
 - 4pc torx: T8, T9, T10, T15
 - 4pc slotted: SL2, SL2.5, SL3, SL4
 - 4pc hex: H3, H4, H5, H6
 - 18pc 1/4 sockets:
 - 4, 5, 5.5, 6, 7, 8, 9, 10, 12mm;
 - 5/32, 3/16, 7/32, 1/4, 9/32, 5/16, 11/32, 3/8, 1/2"

ITEM	Packaging	Box/carton	Gw/Nw(kg)	MEAS(cm)
YJPS-6103B	Bulk	6/12	21/20	43.5*21.5*30

HOTAK

YJPS-6106

38pcs Precision Ratcheting T-driver Set



- FEATURES:**
- Deluxe plastic case.
 - For the handyman in your household.
 - This torque-driver set has an ergonomic handle that allows for entry into difficult-to-reach areas.
 - CR-V bits and chrome plated sockets for long life time use.

- CONTAINS:**
- 1pc dual-color ratchet & screwdriver T handle
 - 1pc 25mm adaptor
 - 1pc soft extension bar
 - 7pcs 1/4 sockets: 4, 5, 5.5, 6, 6.5, 7, 8mm
 - 28pc 5/32 screwdriver bits:
 - 7pc hex: H0.9, H1.3, H2.0, H2.5, H3.0, H4.0
 - 7pc torx: T5, T6, T7, T8, T10, T15, T20
 - 5pc phillips: PH000, PH00, PH0, PH1, PH2
 - 6pc slotted: SL1.5, SL2, SL2.5, SL3, SL3.5, SL4
 - 1pc triangle: 3.0mm
 - 1pc tri wing: 3.0mm
 - 1pc round: 1.0mm

ITEM	Packaging	Box/carton	Gw/Nw(kg)	MEAS(cm)
YJPS-6106B	Bulk	6/24	8.5/7.5	39.5*23*29.5



STAPLE GUN

The staple guns in LONGYUAN have been specialized in order to meet the international universal model. Moreover, the varieties of staple guns can be satisfied by the requirements in the world market.

HOTAK

The staple guns in LONGYUAN are all passed TUV/GS certificate, conform to the environmental requirements and pass tests conducting by third party, which export in Europe and America. Staple guns are in export of large stores and professional tool shops. The annual sales for them can be 3000 thousand sets.

Our factory maintains a good strategic cooperation with these big buyers. The HOTAK brand for staple guns is becoming more and more popular.



YJSG-165

Heavy Duty 3 Way Staple Gun

FEATURES:

- Hi/low power switch for driving control.
- All metal construction.
- Quick jam release button.
- Impact power adjustment.
- Surface: chrome finish.
- For flat wire staples 6-14mm, 7.6mm cable staples 10-12mm, brad nails 14-15mm.

APPLICATION:

- Suitable for all kinds of jobs around the house - upholstery and decoration work, securing frames, and low-voltage (Max 50V) cables, etc.

6-14MM STAPLES	10-12MM U-SHAPE	14-15MM NAILS

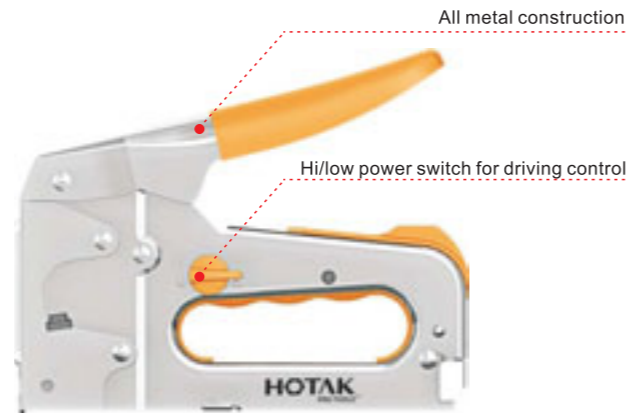

YJSG-170

Heavy Duty Staple And Nail Gun

FEATURES:

- Integrated stapler puller.
- All metal jam free magazine.
- Stapler flush drive surface.
- Compatible with arrow T50 & 140 staples sizes: 6, 8, 10, 12, 14MM(9/16", 1/2", 3/8", 5/16", 1/4").
- Compatible with 14 & 15MM(9/16" & 19/32") 18ga brad nails.

APPLICATION:

- Suitable for insulation, house wrapping, roofing, wiring, carpeting, upholstery.

6-14MM STAPLES	14-15MM NAILS



YJSG-140

Light Duty Staple Gun

FEATURES:

- Light weight for easy use.
- For fine wire staples 6-10mm(1/4"-3/8").
- Fast and simple loading.
- Durable steel handle.

APPLICATION:

- Ideal for decorative work and all fastening works around the home, office, shop, etc.

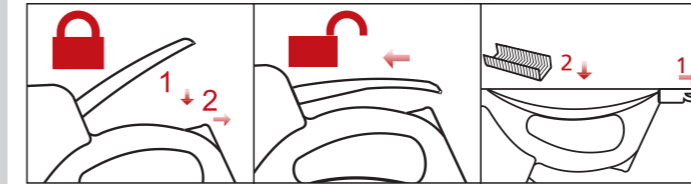

6-10MM STAPLES



YJSG-145

Light Duty Staple Gun

FEATURES:

- For fine wire staples 6-10mm(1/4"-3/8").
- All metal construction.
- Light duty, compact and high efficiency.
- Safety lock.
- Surface: Chrome finish.

APPLICATION:

- Ideal for a wide range of applications, this staple gun can drive staples into some of toughest surfaces.

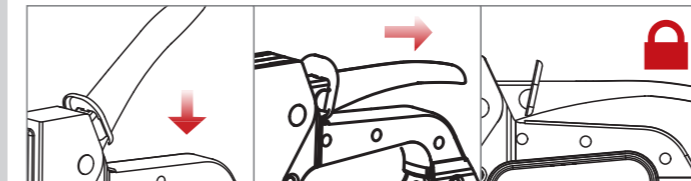

6-10MM STAPLES

YJSG-160

Professional Staple Gun

FEATURES:

- For fine wire staples 4-14mm.
- All metal construction.
- Quick jam release button
- Powerful and high efficiency.
- Impact power adjustment
- Surface: chrome finish.
- Compatible staples: rapid 530, arrow JT21

APPLICATION:

- Ideal for all kinds of fabrics/textile or thin wooden profiles.



4-14MM STAPLES

YJSG-120

4 In 1 Heavy Duty Staple Gun

FEATURES:

- Stapler conveniently hangs from belts and pocket with reversible belt clip.
- High/Low power switch makes every stapling task easily.
- 4 in 1 tools, aluminum housing is lightweight and durable.
- Uses heavy duty, light duty, and cable staples, as well as 18 ga. brads nail
- Surface: paint coating.
- Compatible staples:
 - Heavy duty(1.2): 6-14mm(1/4"-9/16")
 - Light duty(0.7): 6-14mm(1/4"-9/16")
 - Cable: 10-14mm(3/8"-9/16")
 - 18 ga. brad nail: 15mm(1/2"-5/8")

APPLICATION:

- Suitable for insulation, house wrap, roofing, wiring, carpeting, upholstery.

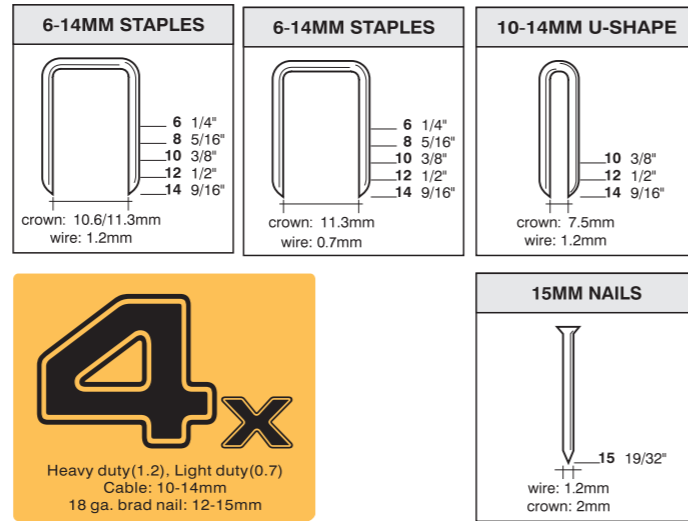

ITEM	Packaging	Box/carton	Gw/Nw(kg)	MEAS(cm)
YJSG-120D	Double blister	6/24	12/11	50.5*35*34.5



YJSG-110

Heavy Duty Staple Gun

FEATURES:

- Drive staples accurately around cable and wire with the pinpoint staple guide.
- Stapler conveniently hangs from belts and pockets with reversible belt clip.
- Easy to squeeze handle has a 30% lower angle.
- Aluminum housing is lightweight and durable.
- Surface: paint coating.
- Compatible staples: rapid 140, arrow T50.

APPLICATION:

- Suitable for insulation, house wrapping, roofing, wiring, carpeting, upholstery.

ITEM	Packaging	Box/carton	Gw/Nw(kg)	MEAS(cm)
YJSG-110D	Double blister	6/24	12/11	50.5*35*34.5

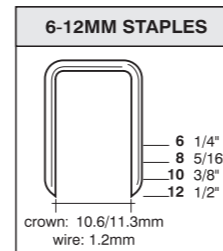
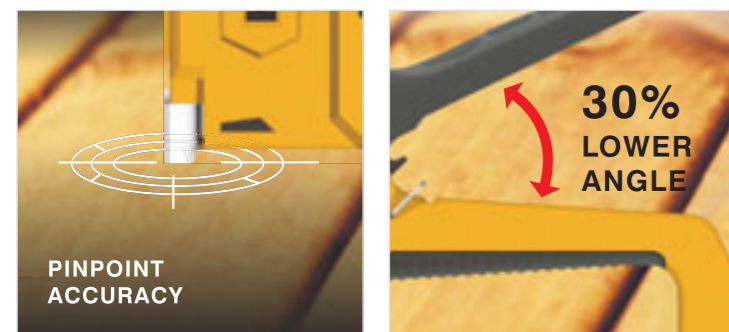

YJSG-115

Heavy Duty Staple And Nail Gun

FEATURES:

- Hi/low power switch for driving control.
- Tilt & fire mechanism-fully drive staples at an angle.
- Integrated stapler puller.
- All metal jam free magazine.
- Stapler flush drive surface.
- Belt clip.

APPLICATION:

- Suitable for insulation, house wrapping, roofing, wiring, carpeting, upholstery.

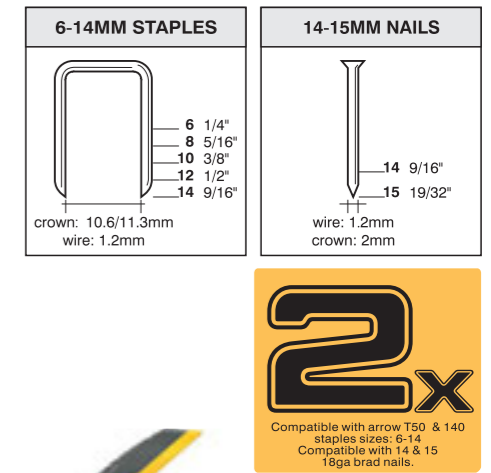

YJSG-085

New Professional Staple Gun Tacker

FEATURES:

- Compact, ergonomic tacker in impact-resistant plastic.
- Black non-slip handle with ergonomic angle. force saving and stable, extremely shock-resistant.
- Handy size for house DIY job or craftsman.
- ABS construction/dual color design / adjustable driving force.
- Compatible staples: rapid 140, arrow T50.

APPLICATION:

- Suitable for insulation, house wrapping, roofing, wiring, carpeting, upholstery.

ITEM	Packaging	Box/carton	Gw/Nw(kg)	MEAS(cm)
YJSG-085D	Double blister	5/20	8.2/7.2	54.5*49.5*22.5

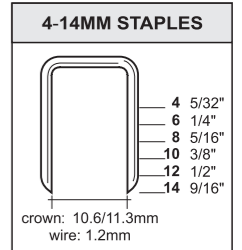

YJSG-001

Medium Duty Staple Gun

FEATURES:

- Versatile, suitable for all kinds flat wire staples crown 10.6-11.3mm.
- For staples 6-14mm.
- All metal construction.
- Surface: chrome finish.

APPLICATION:

- Suitable for securing textiles, canvas, leather, posters, netting, labels, molding, beading, frames, etc.

ITEM	Packaging	Box/carton	Gw/Nw(kg)	MEAS(cm)
YJSG-001D	Double blister	5/20	20.7/19.7	51.5*48.5*29
YJSG-001H	Try-me double blister	5/20	20.3/19.3	51.5*34.5*32.5

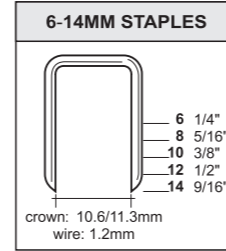

YJSG-002

Medium Duty Staple Gun

FEATURES:

- Versatile, suitable for all kinds flat wire staples crown 10.6-11.3mm.
- For staples 6-14mm.
- All metal construction.
- Surface: paint coating.

APPLICATION:

- Suitable for securing textiles, canvas, leather, posters, netting, labels, molding, beading, frames, etc.

ITEM	Packaging	Box/carton	Gw/Nw(kg)	MEAS(cm)
YJSG-002D	Double blister	5/20	20.7/19.7	51.5*48.5*29
YJSG-002H	Try-me double blister	5/20	20.3/19.3	51.5*34.5*32.5

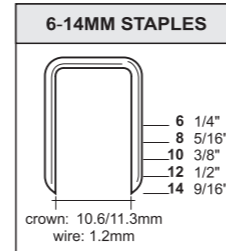

YJSG-003

Medium Duty Staple Gun

FEATURES:

- Versatile, suitable for all kinds flat wire staples crown 10.6-11.3mm.
- For staples 6-14mm.
- All metal construction.
- Surface: pear satin finish.

APPLICATION:

- Suitable for securing textiles, canvas, leather, posters, netting, labels, molding, beading, frames, etc.

ITEM	Packaging	Box/carton	Gw/Nw(kg)	MEAS(cm)
YJSG-003D	Double blister	5/20	20.7/19.7	51.5*48.5*29
YJSG-003H	Try-me double blister	5/20	20.3/19.3	51.5*34.5*32.5

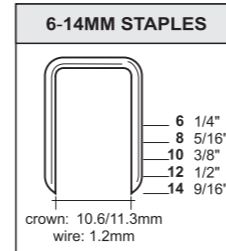

YJSG-005

Heavy Duty 3 Way Staple Gun

FEATURES:

- All metal construction.
- Quick jam release button.
- Impact power adjustment.
- Surface: chrome finish.

APPLICATION:

- Suitable for insulation, house wrapping, roofing, wiring, carpeting, upholstery, and hobby and craft materials

ITEM	Packaging	Box/carton	Gw/Nw(kg)	MEAS(cm)
YJSG-005D	Double blister	6/24	17.3/16.3	43.5*24.5*38.5
YJSG-005H	Try-me double blister	5/20	20/19	49.5*30.5*39.5



YJSG-006

Heavy Duty 3 Way Staple Gun

FEATURES:

- All metal construction.
- Quick jam release button.
- Impact power adjustment.
- Surface: paint coating.

APPLICATION:

- Suitable for insulation, house wrapping, roofing, wiring, carpeting, upholstery, and hobby and craft materials

ITEM	Packaging	Box/carton	Gw/Nw(kg)	MEAS(cm)
YJSG-006D	Double blister	6/24	17.3/16.3	43.5*24.5*38.5
YJSG-006H	Try-me double blister	5/20	20/19	49.5*30.5*39.5

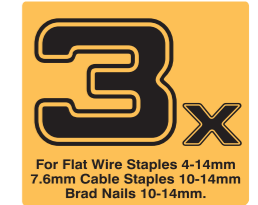

YJSG-007

Heavy Duty 3 Way Staple Gun

FEATURES:

- All metal construction.
- Quick jam release button.
- Impact power adjustment.
- Surface: pear satin finish.

APPLICATION:

- Suitable for insulation, house wrapping, roofing, wiring, carpeting, upholstery, and hobby and craft materials

ITEM	Packaging	Box/carton	Gw/Nw(kg)	MEAS(cm)
YJSG-007D	Double blister	6/24	17.3/16.3	43.5*24.5*38.5
YJSG-007H	Try-me double blister	5/20	20/19	49.5*30.5*39.5



<p>4-14MM STAPLES</p> <p>crown: 10.6/11.3mm wire: 1.2mm</p>	<p>10-12MM U-SHAPE</p> <p>crown: 6.3mm wire: 1.2mm</p>	<p>10-14MM NAILS</p> <p>wire: 1.2mm crown: 2mm</p>



YJSG-009

Professional Staple Gun

FEATURES:

- For fine wire staples 4-14mm.
- All metal construction.
- Quick jam release button.
- Powerful and high efficiency.
- Impact power adjustment
- Compatible staples: rapid 530, arrow Jt21
- Surface: chrome finish.

APPLICATION:

- Ideal for all kinds of fabrics/textile or thin wooden profiles.

ITEM	Packaging	Box/carton	Gw/Nw(kg)	MEAS(cm)
YJSG-009D	Double blister	6/24	17.3/16.3	43.5*24.5*38.5
YJSG-009V	Try-me double blister	6/24	15.4/14.4	48.5*28.5*29.5

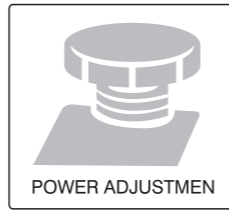

YJSG-010

Professional Staple Gun

FEATURES:

- For fine wire staples 4-14mm.
- All metal construction.
- Quick jam release button.
- Powerful and high efficiency.
- Impact power adjustment
- Compatible staples: rapid 530, arrow Jt21
- Surface: paint coating.

APPLICATION:

- Ideal for all kinds of fabrics/textile or thin wooden profiles.

ITEM	Packaging	Box/carton	Gw/Nw(kg)	MEAS(cm)
YJSG-010D	Double blister	6/24	17.3/16.3	43.5*24.5*38.5
YJSG-010V	Try-me double blister	6/24	15.4/14.4	48.5*28.5*29.5

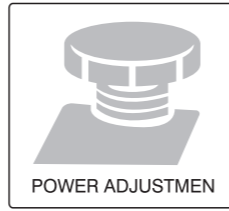

4-14MM STAPLES

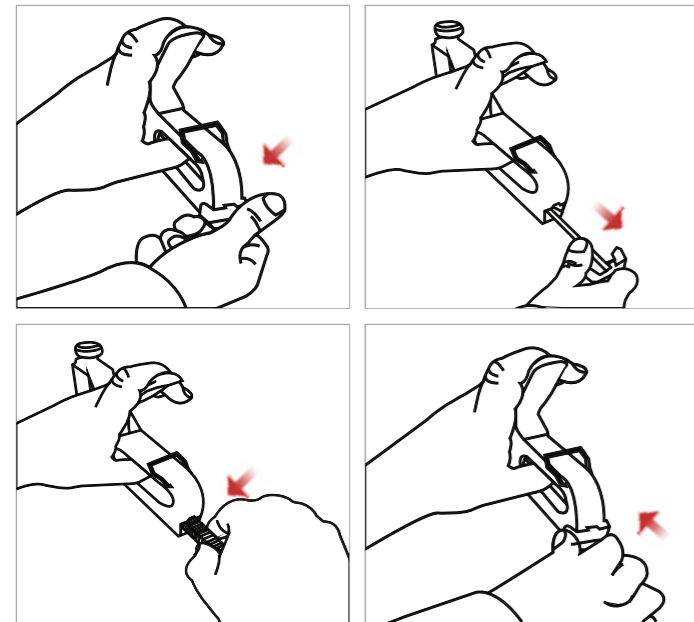
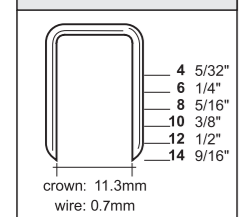

YJSG-012

Medium Duty Staple Gun

FEATURES:

- For fine wire staples 4-8mm.
- All metal construction.
- Light duty, compact and high efficiency.
- Safety lock.
- Surface: paint coating.

APPLICATION:

- Ideal for a wide range of applications, this staple gun can drive staples into some of toughest surfaces.

ITEM	Packaging	Box/carton	Gw/Nw(kg)	MEAS(cm)
YJSG-012D	Double blister	10/40	18/17	38.5*27.5*35.5



4-8MM STAPLES

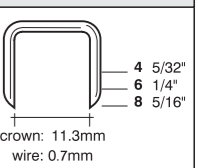

YJSG-013

Medium Duty Staple Gun

FEATURES:

- For fine wire staples 4-8mm.
- All metal construction.
- Light duty, compact and high efficiency.
- Safety lock.
- Surface: chrome finish.

APPLICATION:

- Ideal for a wide range of applications, this staple gun can drive staples into some of toughest surfaces.

ITEM	Packaging	Box/carton	Gw/Nw(kg)	MEAS(cm)
YJSG-013D	Double blister	10/40	18/17	38.5*27.5*35.5



4-8MM STAPLES

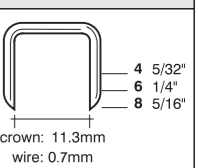

YJSG-080

Medium Duty Staple Gun

FEATURES:

- All metal body Easy loading.
- Easy Storage and portability as the tool has a handle lock.
- Horizontal spring plate design ensures that strokes are accurate.
- Can be operated with one hand.
- Can accommodate 23 series, 13 series and 10F staple pins up to 10mm leg length.
- Leg Lengths 6mm, 8mm, 10mm

APPLICATION:

- Suitable for insulation, house wrapping, roofing, wiring, carpeting, upholstery.

ITEM	Packaging	Box/carton	Gw/Nw(kg)	MEAS(cm)
YJSG-080D	Double blister	6/24	16.3/15.3	45.5*26*37.5



6-10MM STAPLES

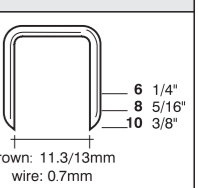

YJSG-039

Light Weight Staple Gun

FEATURES:

- Compact, lightweight ergonomically design, belt hook.
- Visible re-fill indicator.
- Durable hi-impact ABS plastic housing.
- For fine wire staples 4-8mm.

APPLICATION:

- Ideal for home decoration and light duty repair.

ITEM	Packaging	Box/carton	Gw/Nw(kg)	MEAS(cm)
YJSG-039H	Try-me double blister	6/24	8.5/7.5	45.5*38.5*26

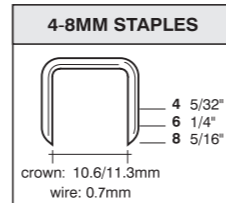

YJSG-040

Light Weight Staple Gun

FEATURES:

- Compact, lightweight ergonomically design, belt hook.
- Visible re-fill indicator.
- Durable hi-impact PC plastic housing.
- For fine wire staples 4-8mm.

APPLICATION:

- Ideal for home decoration and light duty repair.

ITEM	Packaging	Box/carton	Gw/Nw(kg)	MEAS(cm)
YJSG-040H	Try-me double blister	6/24	8.5/7.5	45.5*38.5*26

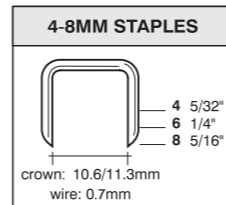

YJSG-042

Light Weight Staple Gun

FEATURES:

- Compact, lightweight ergonomically design, belt hook.
- Visible re-fill indicator.
- Durable hi-impact ABS and aluminum housing.
- For fine wire staples 4-8mm.

APPLICATION:

- Ideal for home decoration and light duty repair.

ITEM	Packaging	Box/carton	Gw/Nw(kg)	MEAS(cm)
YJSG-042H	Try-me double blister	6/24	11.4/10.4	45.5*38.5*26

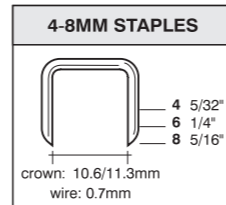

YJSG-050

Light Weight Staple Gun

FEATURES:

- Compact, lightweight ergonomically design, belt hook.
- Visible re-fill indicator.
- Durable hi-impact PC and aluminum housing.
- For fine wire staples 4-8mm.

APPLICATION:

- Ideal for home decoration and light duty repair.

ITEM	Packaging	Box/carton	Gw/Nw(kg)	MEAS(cm)
YJSG-050H	Try-me double blister	6/24	11.4/10.4	45.5*38.5*26

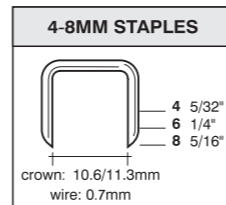

YJSG-015

2-in-1 Staple Gun & Desktop Stapler

FEATURES:

- Forward action stapler design utilizes the user's "push" momentum, making the stapler do the work and keeping it easier for you.
- Desktop paper stapling base easily staples up to 30 pages.
- Great for papers, crafts, school projects, and repairs.
- Includes a detachable desktop paper stapling base and 400 staples
- For fine wire staples 6-10mm(1/4"-3/8").
- Description: ABS housing.

APPLICATION:

- Suitable for insulation, house wrapping, roofing, wiring, carpeting, upholstery.

ITEM	Packaging	Box/carton	Gw/Nw(kg)	MEAS(cm)
YJSG-015H	Double blister	6/24	8.5/7.5	52*30.5*46.5

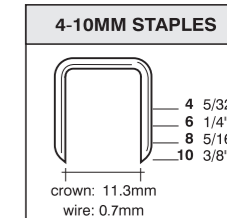

YJSG-016

2-in-1 Staple Gun & Desktop Stapler

FEATURES:

- Forward action stapler design utilizes the user's "push" momentum, making the stapler do the work and keeping it easier for you.
- Desktop paper stapling base easily staples up to 30 pages.
- Great for papers, crafts, school projects, and repairs.
- Includes a detachable desktop paper stapling base and 400 staples
- For fine wire staples 6-10mm(1/4"-3/8").
- Description: PC housing.

APPLICATION:

- Suitable for insulation, house wrapping, roofing, wiring, carpeting, upholstery.

ITEM	Packaging	Box/carton	Gw/Nw(kg)	MEAS(cm)
YJSG-016H	Double blister	6/24	8.5/7.5	52*30.5*46.5

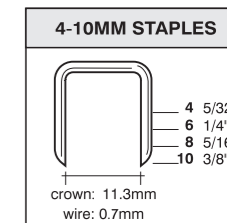

YJSG-018

Light Duty Staple Gun

FEATURES:

- Light weight for easy use.
- For fine wire staples 4-8mm(5/32"-5/16").
- Fast and simple loading.
- Durable steel handle.

APPLICATION:

- Ideal for decorative work and all fastening works around the home, office, shop, etc.

ITEM	Packaging	Box/carton	Gw/Nw(kg)	MEAS(cm)
YJSG-018S	Sliding card	12/48	11.2/10.2	45.5*38.5*24.5

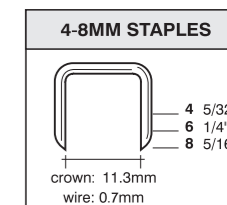

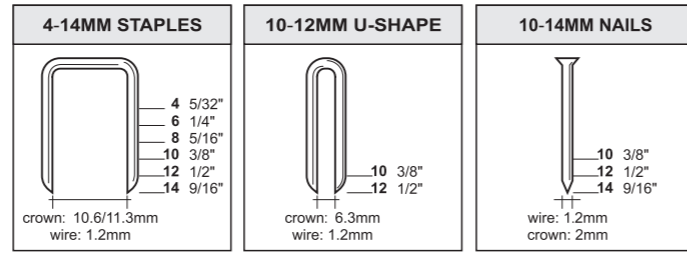
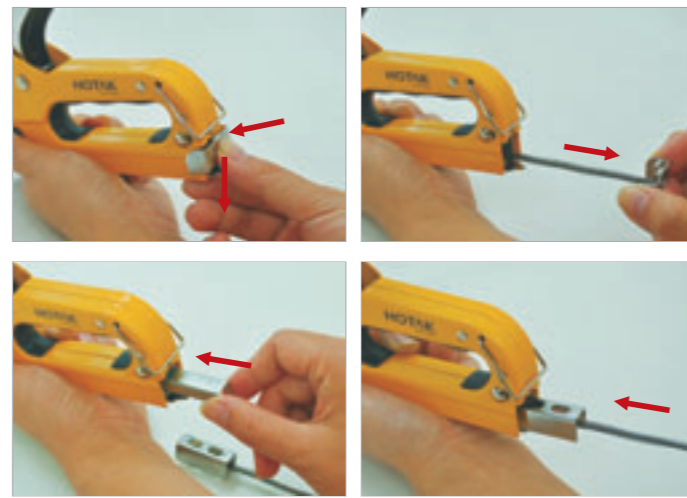

YJSG-022W

Heavy Duty 3 Way Staple Gun

FEATURES:

- FEATURES:
- For flat wire staples 4-14mm, 7.6mm cable staples 10-14mm, brad nails 10-14mm.
- All metal construction.
- Quick jam release button.
- Impact power adjustment.
- Surface: paint finish.

APPLICATION:

- Suitable for all kinds of jobs around the house - upholstery and decoration work, securing frames, and low-voltage (Max 50V) cables, etc.

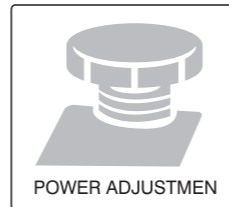
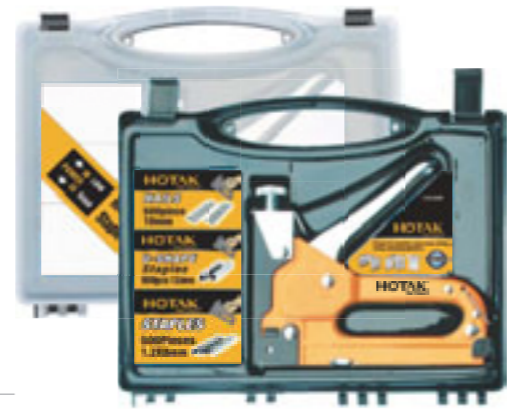

ITEM	Packaging	Box/carton	Gw/Nw(kg)	MEAS(cm)
YJSG-022W	Shrink	6/12	13/12	46*28.5*32

YJSG-023W

Heavy Duty 3 Way Staple Gun

FEATURES:

- FEATURES:
- For flat wire staples 4-14mm, 7.6mm cable staples 10-14mm, brad nails 10-14mm.
- All metal construction.
- Quick jam release button.
- Impact power adjustment.
- Surface: paint finish.

APPLICATION:

- Suitable for all kinds of jobs around the house - upholstery and decoration work, securing frames, and low-voltage (Max 50V) cables, etc.

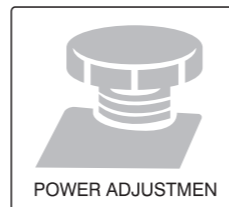

ITEM	Packaging	Box/carton	Gw/Nw(kg)	MEAS(cm)
YJSG-023W	Shrink	6/12	13.5/12.5	49.5*29.5*30.5

YJSG-090

Heavy Duty 3 way Staple Gun With Heavy Duty Staple Remover

FEATURES:

- FEATURES:
- For flat wire staples 4-14mm, 7.6mm cable staples 10-14mm, brad nails 10-14mm.
- All metal construction.
- Quick jam release button.
- Impact power adjustment.
- Surface: chrome finish.

APPLICATION:

- Suitable for all kinds of jobs around the house - upholstery and decoration work, securing frames, and low-voltage (Max 50V) cables, etc.

ITEM	Packaging	Box/carton	Gw/Nw(kg)	MEAS(cm)
YJSG-090D	Double blister	6/24	22.5/21.5	62.5*33*47.5



YJSG-038

Heavy Duty 3 way Staple Gun With Heavy Duty Staple Remover

FEATURES:

- FEATURES:
- For flat wire staples 4-14mm, 7.6mm cable staples 10-14mm, brad nails 10-14mm.
- All metal construction.
- Quick jam release button.
- Impact power adjustment.
- Surface: paint finish.

APPLICATION:

- Suitable for all kinds of jobs around the house - upholstery and decoration work, securing frames, and low-voltage (Max 50V) cables, etc.

ITEM	Packaging	Box/carton	Gw/Nw(kg)	MEAS(cm)
YJSG-038D	Double blister	6/24	20/19	49*33*41.5

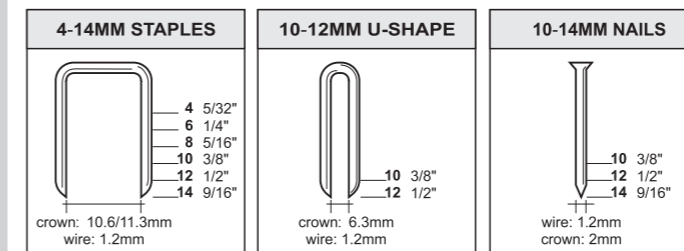

YJSG-033

Medium Duty Staple Gun

FEATURES:

- High-capacity, ergonomic design.
- Recoilless action for comfortable operation.
- Convenient bottom loading for quick and easy jam clearing.
- Handle lock system for additional safety and compact storing.
- Visible re-fill indicator.
- For flat wire staples 6-14mm (1/4"-9/16").

APPLICATION:

- Ideal for securing insulation materials, plastic sheeting, fitted carpets, cardboard, mouldings, beading, edging, frames, etc.

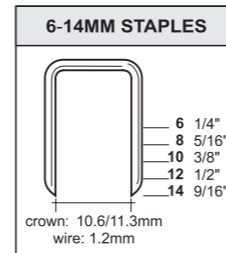

ITEM	Packaging	Box/carton	Gw/Nw(kg)	MEAS(cm)
YJSG-033D	Double blister	6/24	13/12	51.5*46.5*28

YJSG-062

Staple Gun Tacker

FEATURES:

- Durable hi-impact ABS plastic housing,
- Suitable for fine wire staples 6-14mm
- Durable steel handle.

APPLICATION:

- Ideal for decorative work and all fastening works around the home, office, shop, etc.

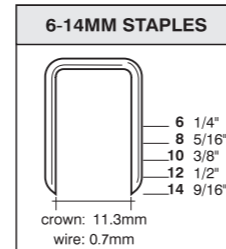

ITEM	Packaging	Box/carton	Gw/Nw(kg)	MEAS(cm)
YJSG-062S	Sliding card	12/48	19/18	47.5*38*38



YJSG-019

Heavy Duty Staple Gun

FEATURES:

- For flat wire staples 4-14mm.
- All metal construction.
- Powerful and high efficiency.
- Impact power adjustment.
- Safety lock.
- Paint and pearl satin finish.

APPLICATION:

- Suitable for securing textiles, canvas, leather, posters, netting, labels, moldings, beading, frames, etc.

ITEM	Packaging	Box/carton	Gw/Nw(kg)	MEAS(cm)
YJSG-019D	Double blister	6/24	19.7/18.7	50.5*31.5*42

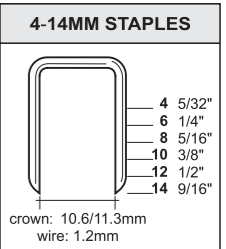

YJSG-063

Heavy Duty Staple Gun

FEATURES:

- Heavy-duty all metal construction.
- Lock down handle.
- Visible re-fill indicator.
- Convenient bottom loading for quick and easy jam clearing.
- For flat wire staples 6-14mm.

APPLICATION:

- Ideal for securing insulation materials, plastic sheeting, fitted carpets, cardboard, mouldings, beading, edging, frames, etc.

ITEM	Packaging	Box/carton	Gw/Nw(kg)	MEAS(cm)
YJSG-063D	Double blister	6/24	20.2/19.2	47*44.5*25.5

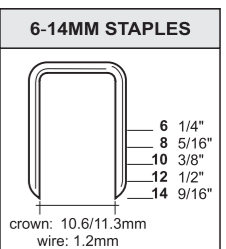

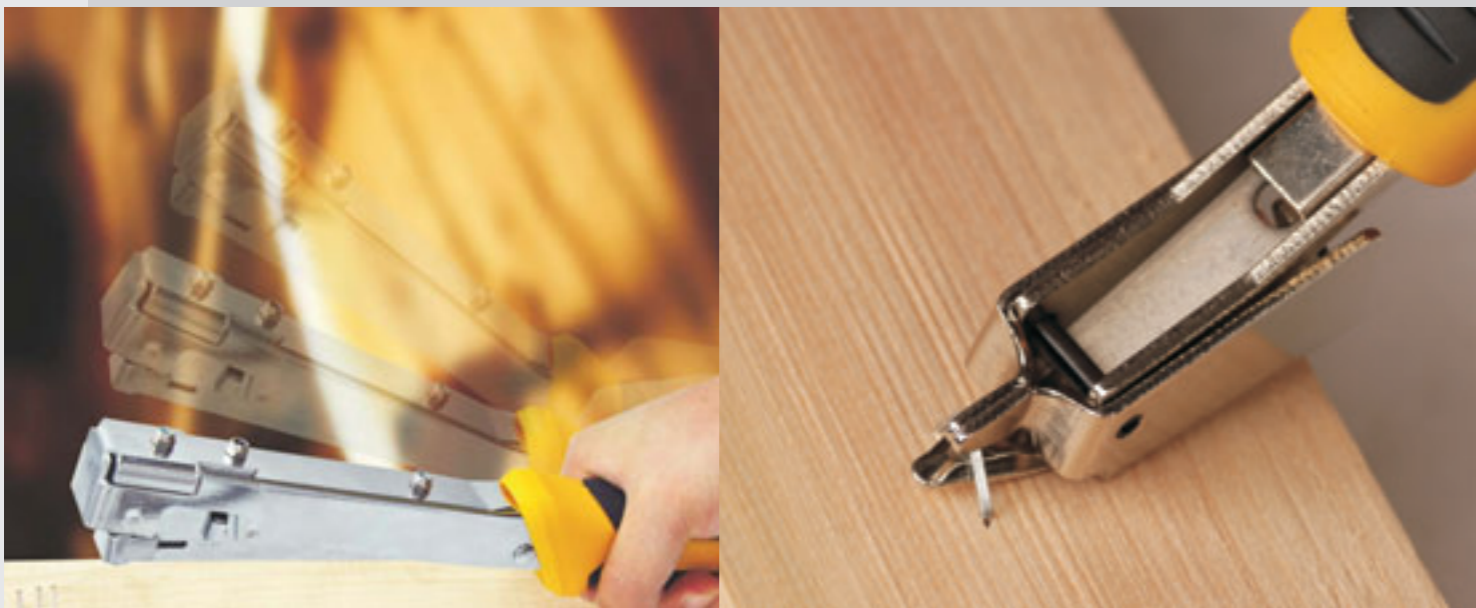

YJSG-035

Heavy Duty Hammer Tacker

FEATURES:

- Rugged steel construction with chrome finish.
- Comfortable rubber grip.
- Convenient bottom loading for quick and easy jam clearing.
- Retractable striking edge.
- One hand operation.
- For flat wire staples 6-14mm.

APPLICATION:

- Ideal for the installation of roofing underlayment, house wrapping, insulation and vapor barriers etc.

6-14MM STAPLES

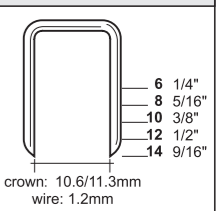

ITEM	Packaging	Box/carton	Gw/Nw(kg)	MEAS(cm)
YJSG-035G	Try-me double blister	5/10	11.2/10.2	48.5*35.5*23

YJSG-095

Staple Gun Tacker

FEATURES:

- Even into some of toughest surfaces with minimum effort.
- All steel construction with high carbon hardened steel parts.
- With rapid ergonomic function, it offers strong penetrating power and quick excellent performance.
- Single-handed ergonomic grip for easy operation.

APPLICATION:

- Apply to asphalt shingles on roofs plywood on sub-flooring, metal lath, under course shakes, assembling shipping crates and a wide variety of other extra heavy-duty building and industrial staple-nail applications.



YJSG-096

Staple Gun Tacker

FEATURES:

- Even into some of toughest surfaces with minimum effort.
- All steel construction with high carbon hardened steel parts.
- With rapid ergonomic function, it offers strong penetrating power and quick excellent performance.
- Single-handed ergonomic grip for easy operation.

APPLICATION:

- Apply to asphalt shingles on roofs plywood on sub-flooring, metal lath, under course shakes, assembling shipping crates and a wide variety of other extra heavy-duty building and industrial staple-nail applications.



YJSG-036

Heavy Duty Staple Remover

FEATURES:

- Ideal for heavy duty jobs, and removing deeply engrained staples, this ergonomic design is used as a lever which reduces the amount of strength needed.
- Firm handle and pliers grip.
- Removes almost any staple.



ITEM	Packaging	Box/carton	Gw/Nw(kg)	MEAS(cm)
YJSG-036D	Double blister	10/40	6/5.5	38.5*36.5*23

YJSG-068

Heavy Duty Hammer Tacker

FEATURES:

- Rugged steel construction with chrome finish.
- Comfortable rubber grip.
- Convenient bottom loading for quick and easy jam clearing.
- Retractable striking edge.
- One hand operation.
- For flat wire staples 6-14mm.

APPLICATION:

- Ideal for the installation of roofing underlayment, house wrapping, insulation and vapor barriers etc.

6-14MM STAPLES

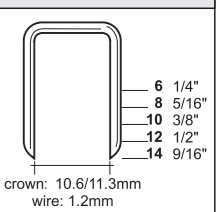

ITEM	Packaging	Box/carton	Gw/Nw(kg)	MEAS(cm)
YJSG-068G	Try-me double blister	5/10	11.2/10.2	48.5*35.5*23



HOTAK

HEX KEY SET

HOTAK hex key wrench can make you work in more convenience environment and fully enjoy the happy when using tools.

Hex key is our advantage product, which can meet the ANSI and DIN standard. Normally HOTAK Hex key can be used permanently.



HOTAK

All processes have been finishing independently in our factory, including heat treatment and surface treatment. so we can track the every step to control the whole aspects of quality. Chrome vanadium steel guarantees an extremely tough cutting edge resistant to fracture and thus accident-proof.



HOTAK hex key can pass the VPA/GS approval and achieve the European union and the united states environmental protection request. accurate diagonal to edge also allows HOTAK tools can be in use more effort and freely. Our raw material is professional S2 and 6150 steel. the feature can meet the industry demands, which ensure that products can be used normally in the more high strength.



9pcs Hex Key Set

YJHK-2540: 9pcs Short Arm Hex Key Set
 YJHK-2541: 9pcs Long Arm Hex Key Set
 YJHK-2542: 9pcs Extra Long Arm Hex Key Set
 YJHK-2543: 9pcs Short Arm Ball Point Hex Key Set
 YJHK-2544: 9pcs Long Arm Ball Point Hex Key Set
 YJHK-2545: 9pcs Extra Long Arm Ball Point Hex Key Set



FEATURES:

- Chrome Vanadium steel for maximum performance.
- Heat treated for hardness more than HRC50.
- Surface: satin finish.

CONTAINS:

- 1.5, 2, 2.5, 3, 4, 5, 6, 8, 10mm

9pcs Hex Key Set

YJHK-2546: 9pcs Short Arm Hex Key Set
 YJHK-2547: 9pcs Long Arm Hex Key Set
 YJHK-2548: 9pcs Extra Long Arm Hex Key Set
 YJHK-2549: 9pcs Short Arm Ball Point Hex Key Set
 YJHK-2550: 9pcs Long Arm Ball Point Hex Key Set
 YJHK-2551: 9pcs Extra Long Arm Ball Point Hex Key Set



FEATURES:

- Chrome Vanadium steel for maximum performance.
- Heat treated for hardness more than HRC50.
- Surface: satin finish.

CONTAINS:

- 1/16", 5/64", 3/32", 1/8", 5/32", 3/16", 1/4", 5/16", 3/8"

9pcs Torx Key Set

YJHK-2552: 9pcs Short Arm Torx Key Set
 YJHK-2553: 9pcs Long Arm Torx Key Set
 YJHK-2554: 9pcs Extra Long Arm Torx Key Set



FEATURES:

- Chrome Vanadium steel for maximum performance.
- Heat treated for hardness more than HRC50.
- Surface: satin finish.

CONTAINS:

- T6, T7, T8, T10, T20, T25, T30, T40, T45

13pcs Hex Key Set

YJHK-2600: 13pcs Short Arm Hex Key Set
 YJHK-2601: 13pcs Long Arm Hex Key Set
 YJHK-2602: 13pcs Extra Long Arm Hex Key Set
 YJHK-2603: 13pcs Short Arm Ball Point Hex Key Set
 YJHK-2604: 13pcs Long Arm Ball Point Hex Key Set
 YJHK-2605: 13pcs Extra Long Arm Ball Point Hex Key Set



FEATURES:

- Chrome Vanadium steel for maximum performance.
- Heat treated for hardness more than HRC50.
- Surface: satin finish.

CONTAINS:

- 1.5, 2.0, 2.5, 3.0, 4.0, 4.5, 5.0, 5.5, 6.0, 7.0, 8.0, 9.0, 10.0mm

13pcs Hex Key Set

YJHK-2606: 13pcs Short Arm Hex Key Set
 YJHK-2607: 13pcs Long Arm Hex Key Set
 YJHK-2608: 13pcs Extra Long Arm Hex Key Set
 YJHK-2609: 13pcs Short Arm Ball Point Hex Key Set
 YJHK-2610: 13pcs Long Arm Ball Point Hex Key Set
 YJHK-2611: 13pcs Extra Long Arm Ball Point Hex Key Set



FEATURES:

- Chrome Vanadium steel for maximum performance.
- Heat treated for hardness more than HRC50.
- Surface: satin finish.

CONTAINS:

- 0.05, 1/16, 5/64, 3/32, 7/64, 1/8, 9/64, 5/32, 3/16, 7/32, 1/4, 5/16, 3/8"

13pcs Torx Key Set

YJHK-2612: 13pcs Short Arm Torx Key Set
 YJHK-2613: 13pcs Long Arm Torx Key Set
 YJHK-2614: 13pcs Extra Long Arm Torx Key Set



FEATURES:

- Chrome Vanadium steel for maximum performance.
- Heat treated for hardness more than HRC50.
- Surface: satin finish.

CONTAINS:

- T5, T6, T7, T8, T9, T10, T15, T20, T25, T27, T30, T40, T45

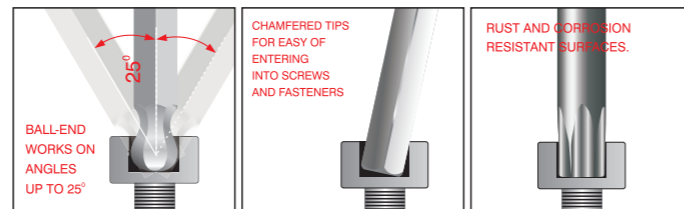

YJHK-2565

8pcs Metric Locking Folding Hex Key Set



FEATURES:

- Chrome vanadium steel for maximum performance.
- Folding design, easy to carry.
- Locking system to fix the position well.
- Surface: black finish.

CONTAINS:

- 1.5, 2, 2.5, 3, 4, 5, 6, 8mm

ITEM	Packaging	Box/carton	Gw/Nw(kg)	MEAS(cm)
YJHK-2565E	Hanging Card	6/48	14.7/13.7	44.5*27.5*29.5

YJHK-2566

8pcs SAE Locking Folding Hex Key Set



FEATURES:

- Chrome vanadium steel for maximum performance.
- Folding design, easy to carry.
- Locking system to fix the position well.
- Surface: black finish.

CONTAINS:

- 3/32", 7/64", 1/8", 9/64", 5/32", 3/16", 7/32", 1/4"

ITEM	Packaging	Box/carton	Gw/Nw(kg)	MEAS(cm)
YJHK-2566E	Hanging Card	6/48	14.7/13.7	44.5*27.5*29.5

YJHK-2567

8pcs Torx Locking Folding Torx Key Set



FEATURES:

- Chrome vanadium steel for maximum performance.
- Folding design, easy to carry.
- Locking system to fix the position well.
- Surface: black finish.

CONTAINS:

- T9, T10, T15, T20, T25, T27, T30, T40

ITEM	Packaging	Box/carton	Gw/Nw(kg)	MEAS(cm)
YJHK-2567E	Hanging Card	6/48	14.7/13.7	44.5*27.5*29.5



YJHK-2575

8pcs Metric Folding Hex Key Set



FEATURES:

- Chrome vanadium steel for maximum performance.
- Folding design, easy to carry.
- Surface: black finish.

CONTAINS:

- 1.5, 2, 2.5, 3, 4, 5, 6, 8mm

ITEM	Packaging	Box/carton	Gw/Nw(kg)	MEAS(cm)
YJHK-2575E	Hanging Card	6/48	11.3/10.3	44.5*27.5*29.5

YJHK-2576

9pcs SAE Folding Hex Key Set



FEATURES:

- Chrome vanadium steel for maximum performance.
- Folding design, easy to carry.
- Surface: black finish.

CONTAINS:

- 5/64", 3/32", 7/64", 1/8", 9/64", 5/32", 3/16", 7/32", 1/4"

ITEM	Packaging	Box/carton	Gw/Nw(kg)	MEAS(cm)
YJHK-2576E	Hanging Card	6/48	11.3/10.3	44.5*27.5*29.5

YJHK-2577

8pcs Torx Folding Torx Key Set



FEATURES:

- Chrome vanadium steel for maximum performance.
- Folding design, easy to carry.
- Surface: black finish.

CONTAINS:

- T9, T10, T15, T20, T25, T27, T30, T40

ITEM	Packaging	Box/carton	Gw/Nw(kg)	MEAS(cm)
YJHK-2577E	Hanging Card	6/48	11.3/10.3	44.5*27.5*29.5



YJHK-621

9pcs SAE Folding Hex Key Set

Big handle



FEATURES:

- Chrome vanadium steel for maximum performance.
- Folding design, and increase aluminum sheet decoration, easy to carry.
- Surface: black finish.

CONTAINS:

- 5/64", 3/32", 7/64", 1/8", 9/64", 5/32", 3/16", 7/32", 1/4"

ITEM	Packaging	Box/carton	Gw/Nw(kg)	MEAS(cm)
YJHK-621E	Hanging Card	12/48	10/9	33.5*22.5*26

YJHK-622

8pcs Metric Folding Hex Key Set

Big handle



FEATURES:

- Chrome vanadium steel for maximum performance.
- Folding design, and increase aluminum sheet decoration, easy to carry.
- Surface: black finish.

CONTAINS:

- 1.5, 2.0, 2.5, 3.0, 4.0, 5.0, 6.0, 8.0mm

ITEM	Packaging	Box/carton	Gw/Nw(kg)	MEAS(cm)
YJHK-622E	Hanging Card	12/48	10/9	33.5*22.5*26

YJHK-623

8pcs Folding Torx Key Set

Big handle



FEATURES:

- Chrome vanadium steel for maximum performance.
- Folding design, and increase aluminum sheet decoration, easy to carry.
- Surface: black finish.

CONTAINS:

- T9, T10, T15, T20, T25, T27, T30, T40

ITEM	Packaging	Box/carton	Gw/Nw(kg)	MEAS(cm)
YJHK-623E	Hanging Card	12/48	10/9	33.5*22.5*26

YJHK-625

7pcs SAE Folding Hex Key Set

Small handle



FEATURES:

- Chrome vanadium steel for maximum performance.
- Folding design, and increase aluminum sheet decoration, easy to carry.
- Surface: black finish.

CONTAINS:

- 5/64", 3/32", 7/64", 1/8", 5/32", 3/16", 7/32"

ITEM	Packaging	Box/carton	Gw/Nw(kg)	MEAS(cm)
YJHK-625E	Hanging Card	12/48	8/7	29*23*24

YJHK-626

7pcs Metric Folding Hex Key Set

Small handle



FEATURES:

- Chrome vanadium steel for maximum performance.
- Folding design, and increase aluminum sheet decoration, easy to carry.
- Surface: black finish.

CONTAINS:

- 1.5, 2.0, 2.5, 3.0, 4.0, 5.0, 6.0, 8.0mm

ITEM	Packaging	Box/carton	Gw/Nw(kg)	MEAS(cm)
YJHK-626E	Hanging Card	12/48	8/7	29*23*24

YJHK-627

7pcs Folding Torx Key Set

Small handle



FEATURES:

- Chrome vanadium steel for maximum performance.
- Folding design, and increase aluminum sheet decoration, easy to carry.
- Surface: black finish.

CONTAINS:

- T9, T10, T15, T20, T25, T27, T30, T40

ITEM	Packaging	Box/carton	Gw/Nw(kg)	MEAS(cm)
YJHK-627E	Hanging Card	12/48	8/7	29*23*24

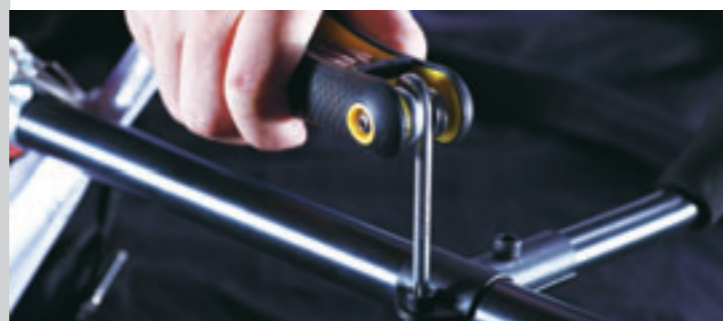

6pcs T-handle Wrench Set

YJHK-2620C: 2.0, 2.5, 3.0, 4.0, 5.0, 6.0mm
 YJHK-2621C: 5/64", 3/32", 1/8", 5/32", 3/16", 1/4"
 YJHK-2622C: T10, T15, T20, T25, T30, T40



FEATURES:

- Ergonomical designed T-handle for greater torque and comfort.
- Chamfered tips for easy entering into screws and fasteners.
- Chrome plated surface, anti-rust and corrosion resistant.
- Surface: satin finish.

ITEM	Packaging	Box/carton	Gw/Nw(kg)	MEAS(cm)
YJHK-2620C	Color box	5/20	13/12	47*40*44.5
YJHK-2621C	Color box	5/20	13/12	47*40*44.5
YJHK-2622C	Color box	5/20	13/12	47*40*44.5

YJHK-2585

14pcs T-handle Wrench Set



FEATURES:

- Ergonomical designed T-handle for greater torque and comfort.
- Chamfered tips for easy entering into screws and fasteners.
- Chrome plated surface, anti-rust and corrosion resistant.
- Surface: satin finish.

CONTAINS:

- Metric: 2.5, 3.0, 4.0, 5.0, 6.0, 8.0, 10.0mm
- SAE: 5/64", 1/8", 9/64", 5/32", 3/16", 1/4", 3/8"

YJHK-645

17in1 Compact Mini Folding Screwdriver Set



FEATURES:

- Chrome Vanadium Steel for maximum performance, tough, lightweight aluminum (composite) body.
- Folding design for compact storage and use, chrome plated to resist rust.

CONTAINS:

- 1pc slotted: 5mm
- 1pc socket adaptor: 4mm
- 2pc phillips: PH1, PH2
- 7pc double end bit:
1.5/PH000 2.0/PH00 2.5/PH0 3.0/PH1 T4/T8 T6/T10 T7/T15

ITEM	Packaging	Box/carton	Gw/Nw(kg)	MEAS(cm)
YJHK-645D	Double blister	12/48	9/8	42.5*34*24.5

9pcs Folding Hex Key Set



YJHK-611: 5/64", 3/32", 7/64", 1/8", 9/64", 5/32", 3/16", 7/32", 1/4"
 YJHK-612: 1.5, 2.0, 2.5, 3.0, 3.5, 4.0, 5.0, 5.5, 6.0mm
 YJHK-613: T7, T8, T9, T10, T15, T20, T25, T27, T30

FEATURES:

- Fashion appearance together with attractive protection against corrosion.
- Hex keys fold out and lock into place.
- Case opens to form a sturdy handle.

ITEM	Packaging	Box/carton	Gw/Nw(kg)	MEAS(cm)
YJHK-611E	Hang card	6/24	6/5	39*31*24.5

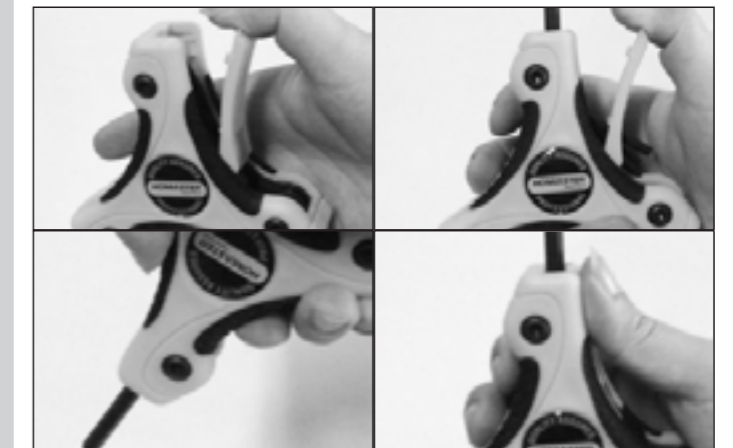



YJHK-2440

9pcs Short Arm Hex Key Set



FEATURES:

- Heat treated for hardness more than HRC50.
- Slip resistant coating improves grip.
- Chamfered tips ease of entry into openings. luxury storage case.
- Surface: chrome plated, color rubber coating.

CONTAINS:

- 1.5, 2.0, 2.5, 3.0, 4.0, 5.0, 6.0, 8.0, 10.0mm.

ITEM	Packaging	Box/carton	Gw/Nw(kg)	MEAS(cm)
YJHK-2440B	Color box	6/24	8.6/7.6	37.5*26.5*18

YJHK-2435

9pcs Extra Long Arm Hex Key Set



FEATURES:

- Heat treated for hardness more than HRC50.
- Slip resistant coating improves grip.
- Chamfered tips ease of entry into openings. luxury storage case.
- Surface: chrome plated, color rubber coating.

CONTAINS:

- 1.5, 2.0, 2.5, 3.0, 4.0, 5.0, 6.0, 8.0, 10.0mm.

ITEM	Packaging	Box/carton	Gw/Nw(kg)	MEAS(cm)
YJHK-2435B	Color box	6/24	14/13	30*26.5*32.5

YJHK-2436

9pcs Extra Long Arm Hex Key Set



FEATURES:

- Heat treated for hardness more than HRC50.
- Slip resistant coating improves grip.
- Chamfered tips ease of entry into openings. luxury storage case.
- Surface: chrome plated, color rubber coating.

CONTAINS:

- 1/16", 5/64", 3/32", 1/8", 5/32", 3/16", 1/4", 5/16", 3/8"

ITEM	Packaging	Box/carton	Gw/Nw(kg)	MEAS(cm)
YJHK-2436B	Color box	6/24	14/13	30*26.5*32.5

YJHK-2441

9pcs Short Arm Hex Key Set



FEATURES:

- Heat treated for hardness more than HRC50.
- Slip resistant coating improves grip.
- Chamfered tips ease of entry into openings. luxury storage case.
- Surface: chrome plated, color rubber coating.

CONTAINS:

- 1/16", 5/64", 3/32", 1/8", 5/32", 3/16", 1/4", 5/16", 3/8"

ITEM	Packaging	Box/carton	Gw/Nw(kg)	MEAS(cm)
YJHK-2441B	Color box	6/24	8.6/7.6	37.5*26.5*18



YJHK-655

11pcs Mini Pocket Folding Wrench Set



FEATURES:

- Chrome vanadium (CR-V) bits have a solid base providing a significant advantage in rigidity and function when compared to conventional bits..
- Delicate appearance and measure is convenient to be carried and used..

CONTAINS:

- 3pc hex: 3, 4, 5mm
- 3pc phillips: PH1, PH2, PH3
- 1pc slotted: 6mm
- 1pc square: 6.35mm
- 3pc socket: 8, 9, 10mm

ITEM	Packaging	Box/carton	Gw/Nw(kg)	MEAS(cm)
YJHK-655D	Double blister	12/48	8.2/7.2	41.5*33.5*20

YJHK-656

8pcs Mini Pocket Folding Wrench Set



FEATURES:

- Chrome vanadium (CR-V) bits have a solid base providing a significant advantage in rigidity and function when compared to conventional bits..
- Delicate appearance and measure is convenient to be carried and used..

CONTAINS:

- 3pc hex: 3, 4, 5mm
- 3pc phillips: PH1, PH2, PH3
- 1pc slotted: 6mm
- 1pc square: 6.35mm

ITEM	Packaging	Box/carton	Gw/Nw(kg)	MEAS(cm)
YJHK-656D	Double blister	12/48	6.2/5.2	33.5*21.5*31.5

YJHK-658

12pcs Mini Pocket Folding Screwdriver & Socket Set



FEATURES:

- Chrome vanadium (CR-V) bits have a solid base providing a significant advantage in rigidity and function when compared to conventional bits..
- Delicate appearance and measure is convenient to be carried and used..

CONTAINS:

- 3pc hex: 3, 4, 5mm
- 3pc phillips: PH1, PH2, PH3
- 1pc slotted: 6mm
- 1pc square: 6.35mm
- 4pc socket: 5, 6, 7, 8mm

ITEM	Packaging	Box/carton	Gw/Nw(kg)	MEAS(cm)
YJHK-658D	Double blister	12/48	9/8	42.5*34*24.5

YJHK-657

4pcs Mini Pocket Folding Wrench Set



FEATURES:

- Chrome vanadium (CR-V) bits have a solid base providing a significant advantage in rigidity and function when compared to conventional bits..
- Delicate appearance and measure is convenient to be carried and used..

CONTAINS:

- 2pc phillips: PH00, PH0
- 2pc slotted: 2, 3mm

ITEM	Packaging	Box/carton	Gw/Nw(kg)	MEAS(cm)
YJHK-657D	Double blister	12/48	3.7/3	37.5*17.5*26.8



46221

46221D1: 9pcs Short Arm Ball Point Hex Key Set
 46221D2: 9pcs Long Arm Ball Point Hex Key Set
 46221D3: 9pcs Extra Long Arm Ball Point Hex Key Set



FEATURES:

- Chrome Vanadium steel for maximum performance.
- Chrome plated for long last and durability.
- Heat treated for hardness more than HRC52.
- Surface: satin finish.

CONTAINS:

- 1.5, 2, 2.5, 3, 4, 5, 6, 8, 10mm

ITEM	Packaging	Box/carton	Gw/Nw(kg)	MEAS(cm)
46221D1	Double blister	6/24	7.5/6.5	29.5*29.5*28
46221D2	Double blister	6/24	10.2/9.2	41.5*29*24.5
46221D3	Double blister	6/24	12/11	41.5*34*24.5

46222

46222D1: 9pcs Short Arm Ball Point Hex Key Set
 46222D2: 9pcs Long Arm Ball Point Hex Key Set
 46222D3: 9pcs Extra Long Arm Ball Point Hex Key Set



FEATURES:

- Chrome Vanadium steel for maximum performance.
- Chrome plated for long last and durability.
- Heat treated for hardness more than HRC52.
- Surface: satin finish.

CONTAINS:

- 1/16", 5/64", 3/32", 1/8", 5/32", 3/16", 1/4", 5/16", 3/8"

ITEM	Packaging	Box/carton	Gw/Nw(kg)	MEAS(cm)
46222D1	Double blister	6/24	7.5/6.5	29.5*29.5*28
46222D2	Double blister	6/24	10.2/9.2	41.5*29*24.5
46222D3	Double blister	6/24	12/11	41.5*34*24.5



46233

46233D1: 9pcs Short Arm Torx Key Set
 46233D2: 9pcs Long Arm Torx Key Set
 46233D3: 9pcs Extra Long Arm Torx Key Set



FEATURES:

- Chrome Vanadium steel for maximum performance.
- Chrome plated for long last and durability.
- Heat treated for hardness more than HRC52.
- Surface: satin finish.

CONTAINS:

- T10, T15, T20, T25, T27, T30, T40, T45, T50

ITEM	Packaging	Box/carton	Gw/Nw(kg)	MEAS(cm)
46233D1	Double blister	6/24	7.5/6.5	29.5*29.5*28
46233D2	Double blister	6/24	10.2/9.2	41.5*29*24.5
46233D3	Double blister	6/24	12/11	41.5*34*24.5



46421

46421D1: 9pcs Short Arm Ball Point Hex Key Set
 46421D2: 9pcs Long Arm Ball Point Hex Key Set
 46421D3: 9pcs Extra Long Arm Ball Point Hex Key Set



FEATURES:

- Chrome Vanadium steel for maximum performance.
- Chrome plated for long last and durability.
- Heat treated for hardness more than HRC52.
- Surface: tip plating, color rubber coating.

CONTAINS:

- 1.5, 2, 2.5, 3, 4, 5, 6, 8, 10mm

ITEM	Packaging	Box/carton	Gw/Nw(kg)	MEAS(cm)
46421D1	Double blister	6/24	7.5/6.5	29.5*29.5*28
46421D2	Double blister	6/24	10.2/9.2	41.5*29*24.5
46421D3	Double blister	6/24	12/11	41.5*34*24.5

46422

46422D1: 9pcs Short Arm Ball Point Hex Key Set
 46422D2: 9pcs Long Arm Ball Point Hex Key Set
 46422D3: 9pcs Extra Long Arm Ball Point Hex Key Set



FEATURES:

- Chrome Vanadium steel for maximum performance.
- Chrome plated for long last and durability.
- Heat treated for hardness more than HRC52.
- Surface: satin finish.

CONTAINS:

- 1/16", 5/64", 3/32", 1/8", 5/32", 3/16", 1/4", 5/16", 3/8"

ITEM	Packaging	Box/carton	Gw/Nw(kg)	MEAS(cm)
46422D1	Double blister	6/24	7.5/6.5	29.5*29.5*28
46422D2	Double blister	6/24	10.2/9.2	41.5*29*24.5
46422D3	Double blister	6/24	12/11	41.5*34*24.5



46433

46433D1: 9pcs Short Arm Torx Key Set
 46433D2: 9pcs Long Arm Torx Key Set
 46433D3: 9pcs Extra Long Arm Torx Key Set



FEATURES:

- Chrome Vanadium steel for maximum performance.
- Chrome plated for long last and durability.
- Heat treated for hardness more than HRC52.
- Surface: satin finish.

CONTAINS:

- T10, T15, T20, T25, T27, T30, T40, T45, T50

ITEM	Packaging	Box/carton	Gw/Nw(kg)	MEAS(cm)
46433D1	Double blister	6/24	7.5/6.5	29.5*29.5*28
46433D2	Double blister	6/24	10.2/9.2	41.5*29*24.5
46433D3	Double blister	6/24	12/11	41.5*34*24.5

TORX ★

The basic shape is a 6-pointed star formed with ear-lobular shaped curves. Compared to recessed hexagon heads, drive efficiency is higher as torque is smoothly and assuredly transmitted to screw while "CAM-OUT" is eliminated



TORX is a registered trademark of acument TM intellectual properties LLC(USA)



55224

55224D1: 9pcs Short Arm Torx Key Set
 55224D2: 9pcs Long Arm Torx Key Set
 55224D3: 9pcs Extra Long Arm Torx Key Set



FEATURES:

- Chrome Vanadium steel for maximum performance.
- Chrome plated for long last and durability.
- Heat treated for hardness more than HRC52.
- Surface: satin finish.

CONTAINS:

- T10, T15, T20, T25, T27, T30, T40, T45, T50

ITEM	Packaging	Box/carton	Gw/Nw(kg)	MEAS(cm)
55224D1	Bulk	6/48		35.5*33.5*18.5
55224D2	Bulk	6/36	13/12	30*25*32.5
55224D3	Bulk	10/40	9.3/8.3	29.5*29.5*28

55221

55221D1: 10pcs Short Arm Ball point hex key set
 55221D2: 10pcs Long Arm Ball point hex key set
 55221D3: 10pcs Extra Long Arm Ball point hex key set



FEATURES:

- Chrome Vanadium steel for maximum performance.
- Chrome plated for long last and durability.
- Heat treated for hardness more than HRC52.
- Surface: satin finish.

CONTAINS:

- 1.27, 1.5, 2, 2.5, 3, 4, 5, 6, 8, 10mm

ITEM	Packaging	Box/carton	Gw/Nw(kg)	MEAS(cm)
55221D1	Bulk	6/48	13/12	35.5*33.5*18.5
55221D2	Bulk	6/36	14/13	30*25*32.5
55221D3	Bulk	10/40	17.5/16.5	29.5*29.5*28

55222

55222D1: 13pcs Short Arm Ball point hex key set
 55222D2: 13pcs Long Arm Ball point hex key set
 55222D3: 13pcs Extra Long Arm Ball point hex key set



FEATURES:

- Chrome Vanadium steel for maximum performance.
- Chrome plated for long last and durability.
- Heat treated for hardness more than HRC52.
- Surface: satin finish.

CONTAINS:

- 0.05", 1/16", 5/64", 3/32", 7/64", 1/8", 5/64", 5/32", 3/16", 7/32", 1/4", 5/16", 3/8"

ITEM	Packaging	Box/carton	Gw/Nw(kg)	MEAS(cm)
55222D1	Bulk	6/36	10/9	30*19*32.5
55222D2	Bulk	10/60	23.5/22.5	35.5*25*39
55222D3	Bulk	10/40	19.5/18.5	31.5*29.5*27.5

55239

55239D1: 25pcs Short Arm Ball point hex key set
 55239D2: 25pcs Long Arm Ball point hex key set
 55239D3: 25pcs Extra Long Arm Ball point hex key set



FEATURES:

- Chrome Vanadium steel for maximum performance.
- Chrome plated for long last and durability.
- Heat treated for hardness more than HRC52.
- Surface: satin finish.

CONTAINS:

- 12pc SAE hex key:
 1/16", 5/64", 3/32", 7/64", 1/8", 9/64", 5/32", 3/16", 7/32", 1/4", 5/16", 3/8"
- 13pc metric hex key:
 1.27, 1.5, 2, 2.5, 3, 4, 4.5, 5, 5.5, 6, 7, 8, 10mm



55331

55331D1: 9pcs Short Arm Torx Key Set
 55331D2: 9pcs Long Arm Torx Key Set
 55331D3: 9pcs Extra Long Arm Torx Key Set



FEATURES:

- Chrome Vanadium steel for maximum performance.
- Chrome plated for long last and durability.
- Heat treated for hardness more than HRC52.
- Surface: black finish.

CONTAINS:

- T10, T15, T20, T25, T27, T30, T40, T45, T50

ITEM	Packaging	Box/carton	Gw/Nw(kg)	MEAS(cm)
55331D1	Bulk	6/48		35.5*33.5*18.5
55331D2	Bulk	6/36	13/12	30*25*32.5
55331D3	Bulk	10/40	9.3/8.3	29.5*29.5*28

55311

55311D1: 10pcs Short Arm Ball point hex key set
 55311D2: 10pcs Long Arm Ball point hex key set
 55311D3: 10pcs Extra Long Arm Ball point hex key set



FEATURES:

- Chrome Vanadium steel for maximum performance.
- Chrome plated for long last and durability.
- Heat treated for hardness more than HRC52.
- Surface: black finish.

CONTAINS:

- 1.27, 1.5, 2, 2.5, 3, 4, 5, 6, 8, 10mm

ITEM	Packaging	Box/carton	Gw/Nw(kg)	MEAS(cm)
55311D1	Bulk	6/48	13/12	35.5*33.5*18.5
55311D2	Bulk	6/36	14/13	30*25*32.5
55311D3	Bulk	10/40	17.5/16.5	29.5*29.5*28

55312

55312D1: 13pcs Short Arm Ball point hex key set
 55312D2: 13pcs Long Arm Ball point hex key set
 55312D3: 13pcs Extra Long Arm Ball point hex key set



FEATURES:

- Chrome Vanadium steel for maximum performance.
- Chrome plated for long last and durability.
- Heat treated for hardness more than HRC52.
- Surface: black finish.

CONTAINS:

- 0.05", 1/16", 5/64", 3/32", 7/64", 1/8", 5/64", 5/32", 3/16", 7/32", 1/4", 5/16", 3/8"

ITEM	Packaging	Box/carton	Gw/Nw(kg)	MEAS(cm)
55312D1	Bulk	6/36	10/9	30*19*32.5
55312D2	Bulk	10/60	23.5/22.5	35.5*25*39
55312D3	Bulk	10/40	19.5/18.5	31.5*29.5*27.5

55329

55329D1: 25pcs Short Arm Ball point hex key set
 55329D2: 25pcs Long Arm Ball point hex key set
 55329D3: 25pcs Extra Long Arm Ball point hex key set



FEATURES:

- Chrome Vanadium steel for maximum performance.
- Chrome plated for long last and durability.
- Heat treated for hardness more than HRC52.
- Surface: black finish.

CONTAINS:

- 12pc SAE hex key:
 1/16", 5/64", 3/32", 7/64", 1/8", 9/64", 5/32", 3/16", 7/32", 1/4", 5/16", 3/8"
- 13pc metric hex key:
 1.27, 1.5, 2, 2.5, 3, 4, 4.5, 5, 5.5, 6, 7, 8, 10mm





9pcs Hex Key Set

YJHK-160B: 9pcs Extra Long Arm Ball point hex key set
YJHK-161B: 9pcs Long Arm Ball point hex key set



FEATURES:

- Chrome Vanadium steel for maximum performance.
- Chrome plated for long last and durability.
- Heat treated for hardness more than HRC52.
- Surface: satin finish.

CONTAINS:

- 1.5, 2, 2.5, 3, 4, 5, 6, 8, 10mm

ITEM	Packaging	Box/carton	Gw/Nw(kg)	MEAS(cm)
Long Arm	Double blister	10/40	15.2/14.2	38.5*27*45
Extra Long Arm	Double blister	10/40	19/18	43.5*33.5*38.5

9pcs Hex Key Set

YJHK-160A: 9pcs Extra Long Arm hex key set
YJHK-161A: 9pcs Long Arm hex key set



FEATURES:

- Chrome Vanadium steel for maximum performance.
- Chrome plated for long last and durability.
- Heat treated for hardness more than HRC52.
- Surface: satin finish.

CONTAINS:

- 1.5, 2, 2.5, 3, 4, 5, 6, 8, 10mm

ITEM	Packaging	Box/carton	Gw/Nw(kg)	MEAS(cm)
Long Arm	Double blister	10/40	15.2/14.2	38.5*27*45
Extra Long Arm	Double blister	10/40	19/18	43.5*33.5*38.5



9pcs Hex Key Set

YJHK-166A: 9pcs Extra Long Arm Ball point hex key set
YJHK-163A: 9pcs Long Arm Ball point hex key set



FEATURES:

- Chrome Vanadium steel for maximum performance.
- Chrome plated for long last and durability.
- Heat treated for hardness more than HRC52.
- Surface: satin finish.

CONTAINS:

- 1/16", 5/64", 3/32", 1/8", 5/32", 3/16", 1/4", 5/16", 3/8"

ITEM	Packaging	Box/carton	Gw/Nw(kg)	MEAS(cm)
Long Arm	Double blister	10/40	15.2/14.2	38.5*27*45
Extra Long Arm	Double blister	10/40	19/18	43.5*33.5*38.5

9pcs Hex Key Set

YJHK-166B: 9pcs Extra Long Arm hex key set
YJHK-163B: 9pcs Long Arm hex key set



FEATURES:

- Chrome Vanadium steel for maximum performance.
- Chrome plated for long last and durability.
- Heat treated for hardness more than HRC52.
- Surface: satin finish.

CONTAINS:

- 1/16", 5/64", 3/32", 1/8", 5/32", 3/16", 1/4", 5/16", 3/8"

ITEM	Packaging	Box/carton	Gw/Nw(kg)	MEAS(cm)
Long Arm	Double blister	10/40	15.2/14.2	38.5*27*45
Extra Long Arm	Double blister	10/40	19/18	43.5*33.5*38.5

9pcs Torx Key Set

YJHK-162: 9pcs Extra Long Art Torx Key Set
YJHK-167: 9pcs Long Art Torx Key Set



FEATURES:

- Chrome Vanadium steel for maximum performance.
- Chrome plated for long last and durability.
- Heat treated for hardness more than HRC52.
- Surface: satin finish.

CONTAINS:

- T8, T10, T15, T20, T27, T30, T40, T50, T55

ITEM	Packaging	Box/carton	Gw/Nw(kg)	MEAS(cm)
Long Arm	Double blister	10/40	15.2/14.2	38.5*27*45
Extra Long Arm	Double blister	10/40	19/18	43.5*33.5*38.5



YJHK-165

YJHK-165B: 8pcs Long Arm hex key set
YJHK-165A: 8pcs Long Arm Ball point hex key set



FEATURES:

- Chrome Vanadium steel for maximum performance.
- Chrome plated for long last and durability.
- Heat treated for hardness more than HRC52.
- Surface: satin finish.

CONTAINS:

- 1.27, 1.5, 2, 2.5, 3, 4, 5, 6mm

ITEM	Packaging	Box/carton	Gw/Nw(kg)	MEAS(cm)
YJHK-165	Double blister	10/40	8.3/7.3	35.5*27*32.7

YJHK-164

YJHK-164B: 8pcs Long Arm hex key set
YJHK-164A: 8pcs Long Arm Ball point hex key set



FEATURES:

- Chrome Vanadium steel for maximum performance.
- Chrome plated for long last and durability.
- Heat treated for hardness more than HRC52.
- Surface: satin finish.

CONTAINS:

- 0.05, 1/16, 5/64, 3/32, 1/8, 5/32, 3/16, 1/4

ITEM	Packaging	Box/carton	Gw/Nw(kg)	MEAS(cm)
YJHK-164	Double blister	10/40	8.3/7.3	35.5*27*32.7

YJHK-168

8pcs Long Art Torx Key Set



FEATURES:

- Chrome Vanadium steel for maximum performance.
- Chrome plated for long last and durability.
- Heat treated for hardness more than HRC52.
- Surface: satin finish.

CONTAINS:

- T9, T10, T15, T20, T25, T27, T30, T40

ITEM	Packaging	Box/carton	Gw/Nw(kg)	MEAS(cm)
YJHK-168	Double blister	10/40	8.3/7.3	35.5*27*32.7

9pcs Metric Hex Key Set

48211D2: 9pcs Long Arm hex key set
48211D3: 9pcs Extra Long Arm hex key set
48221D2: 9pcs Long Arm Ball point hex key set
48221D3: 9pcs Extra Long Arm Ball point hex key set



FEATURES:

- Chrome Vanadium steel for maximum performance.
- Chrome plated for long last and durability.
- Heat treated for hardness more than HRC52.
- Surface: satin finish.

CONTAINS:

- 1.5, 2, 2.5, 3, 4, 5, 6, 8, 10mm

12pcs SAE Hex Key Set

48212D2: 12pcs Long Arm hex key set
48212D3: 12pcs Extra Long Arm hex key set
48222D2: 12pcs Long Arm Ball point hex key set
48222D3: 12pcs Extra Long Arm Ball point hex key set



FEATURES:

- Chrome Vanadium steel for maximum performance.
- Chrome plated for long last and durability.
- Heat treated for hardness more than HRC52.
- Surface: satin finish.

CONTAINS:

- 1/16", 5/64", 3/32", 1/8", 5/32", 3/16", 7/32", 1/4", 5/16", 3/8"





9pcs Hex Key Set

YJHK-192A: 9pcs Short Arm Ball point hex key set
 YJHK-191A: 9pcs Long Arm Ball point hex key set
 YJHK-190A: 9pcs Extra Long Arm Ball point hex key set



FEATURES:

- Chrome Vanadium steel for maximum performance.
- Chrome plated for long last and durability.
- Heat treated for hardness more than HRC52.
- Surface: satin finish.

CONTAINS:

- 1.5, 2, 2.5, 3, 4, 5, 6, 8, 10mm

ITEM	Packaging	Box/carton	Gw/Nw(kg)	MEAS(cm)
Short Arm	Double blister	6/24	7.5/6.5	29.5*29.5*28
Long Arm	Double blister	6/24	10.2/9.2	41.5*29*24.5
Extra Long Arm	Double blister	6/24	12/11	41.5*34*24.5

9pcs Hex Key Set

YJHK-192B: 9pcs Short Arm hex key set
 YJHK-191B: 9pcs Long Arm hex key set
 YJHK-190B: 9pcs Extra Long Arm hex key set



FEATURES:

- Chrome Vanadium steel for maximum performance.
- Chrome plated for long last and durability.
- Heat treated for hardness more than HRC52.
- Surface: satin finish.

CONTAINS:

- 1.5, 2, 2.5, 3, 4, 5, 6, 8, 10mm

ITEM	Packaging	Box/carton	Gw/Nw(kg)	MEAS(cm)
Short Arm	Double blister	6/24	7.5/6.5	29.5*29.5*28
Long Arm	Double blister	6/24	10.2/9.2	41.5*29*24.5
Extra Long Arm	Double blister	6/24	12/11	41.5*34*24.5



9pcs Hex Key Set

YJHK-189A: 9pcs Short Arm Ball point hex key set
 YJHK-188A: 9pcs Long Arm Ball point hex key set
 YJHK-187A: 9pcs Extra Long Arm Ball point hex key set



FEATURES:

- Chrome Vanadium steel for maximum performance.
- Chrome plated for long last and durability.
- Heat treated for hardness more than HRC52.
- Surface: satin finish.

CONTAINS:

- 1/16", 5/64", 3/32", 1/8", 5/32", 3/16", 1/4", 5/16", 3/8"

ITEM	Packaging	Box/carton	Gw/Nw(kg)	MEAS(cm)
Short Arm	Double blister	6/24	7.5/6.5	29.5*29.5*28
Long Arm	Double blister	6/24	10.2/9.2	41.5*29*24.5
Extra Long Arm	Double blister	6/24	12/11	41.5*34*24.5

9pcs Hex Key Set

YJHK-189B: 9pcs Short Arm hex key set
 YJHK-188B: 9pcs Long Arm hex key set
 YJHK-187B: 9pcs Extra Long Arm hex key set



FEATURES:

- Chrome Vanadium steel for maximum performance.
- Chrome plated for long last and durability.
- Heat treated for hardness more than HRC52.
- Surface: satin finish.

CONTAINS:

- 1/16", 5/64", 3/32", 1/8", 5/32", 3/16", 1/4", 5/16", 3/8"

ITEM	Packaging	Box/carton	Gw/Nw(kg)	MEAS(cm)
Short Arm	Double blister	6/24	7.5/6.5	29.5*29.5*28
Long Arm	Double blister	6/24	10.2/9.2	41.5*29*24.5
Extra Long Arm	Double blister	6/24	12/11	41.5*34*24.5

9pcs Torx Key Set

YJHK-195: 9pcs Short Arm Torx Key Set
 YJHK-194: 9pcs Long Arm Torx Key Set
 YJHK-193: 9pcs Extra Long Arm Torx Key Set



FEATURES:

- Chrome Vanadium steel for maximum performance.
- Chrome plated for long last and durability.
- Heat treated for hardness more than HRC52.
- Surface: satin finish.

CONTAINS:

- T10, T15, T20, T25, T27, T30, T40, T45, T50

ITEM	Packaging	Box/carton	Gw/Nw(kg)	MEAS(cm)
Short Arm	Double blister	6/24	7.5/6.5	29.5*29.5*28
Long Arm	Double blister	6/24	10.2/9.2	41.5*29*24.5
Extra Long Arm	Double blister	6/24	12/11	41.5*34*24.5



YJHK-2138

9pcs Extra Long Arm Hex Key Set



FEATURES:

- Made of CR-V steel for strength and durability.
- Short length design at both "L" tip can reach narrow spaces.
- Both the hex end shape design is bent 90o in opposite angle, thus enabling to work in tight space, requires only a requires only a minimum of 30o turning angle.
- Surface: satin finish.

CONTAINS:

- 1.5, 2, 2.5, 3, 4, 5, 6, 8, 10mm

ITEM	Packaging	Box/carton	Gw/Nw(kg)	MEAS(cm)
YJHK-2138D	Double blister	6/48	23.2/22.2	47.5*35.5*43.5

YJHK-2173

9pcs Extra Long Arm Hex Key Set



FEATURES:

- Made of CR-V steel for strength and durability.
- Short length design at both "L" tip can reach narrow spaces.
- Both the hex end shape design is bent 90o in opposite angle, thus enabling to work in tight space, requires only a requires only a minimum of 30o turning angle.
- Surface: tip plating, color rubber coating.

CONTAINS:

- 1.5, 2, 2.5, 3, 4, 5, 6, 8, 10mm

ITEM	Packaging	Box/carton	Gw/Nw(kg)	MEAS(cm)
YJHK-2173D	Double blister	6/48	23.2/22.2	47.5*35.5*43.5

YJHK-196

YJHK-196B: 9pc Long Arm Hex Key Set
 YJHK-196A: 9pc Long Arm Ball Point Hex Key Set



FEATURES:

- Chrome Vanadium steel for maximum performance.
- Chrome plated for long last and durability.
- Heat treated for hardness more than HRC52.
- Surface: satin finish.

CONTAINS:

- 1.5, 2, 2.5, 3, 4, 5, 6, 8, 10mm

ITEM	Packaging	Box/carton	Gw/Nw(kg)	MEAS(cm)
YJHK-196	Double blister	6/24	10.3/9.3	27.5*26.5*36.5

YJHK-197

YJHK-197B: 9pc Long Arm Hex Key Set
 YJHK-197A: 9pc Long Arm Ball Point Hex Key Set



FEATURES:

- Chrome Vanadium steel for maximum performance.
- Chrome plated for long last and durability.
- Heat treated for hardness more than HRC52.
- Surface: satin finish.

CONTAINS:

- 1/16", 5/64", 3/32", 1/8", 5/32", 3/16", 1/4", 5/16", 3/8"

ITEM	Packaging	Box/carton	Gw/Nw(kg)	MEAS(cm)
YJHK-197	Double blister	6/24	10.3/9.3	27.5*26.5*36.5





YJHK-200

YJHK-200S: 13pcs Short Arm Ball Point Hex Key Set
 YJHK-200L: 13pcs Long Arm Ball Point Hex Key Set
 YJHK-200E: 13pcs Extra Long Arm Ball Point Hex Key Set



FEATURES:

- Chrome Vanadium steel for maximum performance.
- Chrome plated for long last and durability.
- Heat treated for hardness more than HRC52.
- Surface: satin finish.

CONTAINS:

- 1.27, 1.5, 2, 2.5, 3, 3.5, 4, 5, 5.5, 6, 7, 8, 10mm

ITEM	Packaging	Box/carton	Gw/Nw(kg)	MEAS(cm)
YJHK-200	Double blister	6/24	15/14	35.5*35*28.5

YJHK-201

YJHK-201S: 13pcs Short Arm Ball Point Hex Key Set
 YJHK-201L: 13pcs Long Arm Ball Point Hex Key Set
 YJHK-201E: 13pcs Extra Long Arm Ball Point Hex Key Set



FEATURES:

- Chrome Vanadium steel for maximum performance.
- Chrome plated for long last and durability.
- Heat treated for hardness more than HRC52.
- Surface: satin finish.

CONTAINS:

- 0.05", 1/16", 5/64", 3/32", 7/64", 1/8", 5/64", 5/32", 3/16", 7/32", 1/4", 5/16", 3/8"

ITEM	Packaging	Box/carton	Gw/Nw(kg)	MEAS(cm)
YJHK-201	Double blister	6/24	15/14	35.5*35*28.5

69283

18pcs Hex Key Set



FEATURES:

- Chrome vanadium steel for maximum performance.
- Heat treated for hardness more than HRC52.
- Surface: satin finish.

CONTAINS:

- 9pcs Mitric: 1.5, 2, 2.5, 3, 4, 5, 6, 8, 10mm
- 9pcs SAE: 1/16", 5/64", 3/32", 1/8", 5/32", 3/16", 1/4", 5/16", 3/8"

69281

18pcs Hex Key Set



FEATURES:

- Chrome vanadium steel for maximum performance.
- Heat treated for hardness more than HRC52.
- Surface: satin finish.

CONTAINS:

- 9pc Mitric: 1.5, 2, 2.5, 3, 4, 5, 6, 8, 10mm
- 9pc Torx: T10, T15, T20, T25, T27, T30, T40, T45, T50



70321X3

8pcs Extra Long Arm Ball Point Hex Key



FEATURES:

- Chrome vanadium steel for maximum performance.
- Heat treated for hardness more than HRC52.
- Surface: satin finish.

CONTAINS:

- 2, 2.5, 3, 4, 5, 6, 8, 10mm

70322X3

8pcs Extra Long Arm Ball Point Hex Key



FEATURES:

- Chrome vanadium steel for maximum performance.
- Heat treated for hardness more than HRC52.
- Surface: satin finish.

CONTAINS:

- 5/64", 3/32", 1/8", 5/32", 3/16", 7/32", 1/4", 5/16"

YJHK-325D

18pcs Ball Point Hex key And Star Driver Set



FEATURES:

- Chrome Vanadium steel for maximum performance.
- Chrome plated for long last and durability.
- Heat treated for hardness more than HRC52.
- Surface: satin finish.

CONTAINS:

- 9pc ball point hex key: 1.5, 2, 2.5, 3, 4, 5, 6, 8, 10mm
- 9pc Torx key: T10, T15, T20, T25, T27, T30, T40, T45, T50

ITEM	Packaging	Box/carton	Gw/Nw(kg)	MEAS(cm)
YJHK-325D	Double blister	5/20	15.4/14.4	41*35.5*27.5

YJHK-327D

18pcs Ball Point Hex key And Star Driver Set



FEATURES:

- Chrome Vanadium steel for maximum performance.
- Chrome plated for long last and durability.
- Heat treated for hardness more than HRC52.
- Surface: satin finish.

CONTAINS:

- 9pc ball point hex key: 1.5, 2, 2.5, 3, 4, 5, 6, 8, 10mm
- 8pc Torx key: T9, T10, T15, T20, T25, T27, T30, T40

ITEM	Packaging	Box/carton	Gw/Nw(kg)	MEAS(cm)
YJHK-327D	Double blister	6/24	16.3/15.3	46*43.5*28.5

65289D1

18pcs Short Arm Combo Hex Key Set



FEATURES:

- High Quality Chrome Vanadium Steel, guarantees an extremely tough cutting edge resistant to fracture and thus accident-proof life time 100% extend.
- Surface: satin finish.

CONTAINS:

- Metric: 1.5mm, 2mm, 2.5mm, 3mm, 4mm, 5mm, 6mm, 8mm, 10mm
- SAE: 1/16", 5/64", 3/32", 1/8", 5/32", 3/16", 1/4", 5/16", 3/8"

ITEM	Packaging	Box/carton	Gw/Nw(kg)	MEAS(cm)
65289D1	Double blister	6/24	16.6/15.6	49.5*28*38



65287D1

18pcs Short Arm Combo Hex Key Set



FEATURES:

- High Quality Chrome Vanadium Steel, guarantees an extremely tough cutting edge resistant to fracture and thus accident-proof life time 100% extend.
- Surface: satin finish.

CONTAINS:

- SAE: 1/16", 5/64", 3/32", 1/8", 5/32", 3/16", 1/4", 5/16", 3/8"
- Torx: T10, T15, T20, T25, T27, T30, T40, T45, T50

ITEM	Packaging	Box/carton	Gw/Nw(kg)	MEAS(cm)
65287D1	Double blister	6/24	16.6/15.6	49.5*28*38



65288D1

18pcs Short Arm Combo Hex Key Set



FEATURES:

- High Quality Chrome Vanadium Steel, guarantees an extremely tough cutting edge resistant to fracture and thus accident-proof life time 100% extend.
- Surface: satin finish.

CONTAINS:

- Metric: 1.5mm, 2mm, 2.5mm, 3mm, 4mm, 5mm, 6mm, 8mm, 10mm
- Torx: T10, T15, T20, T25, T27, T30, T40, T45, T50

ITEM	Packaging	Box/carton	Gw/Nw(kg)	MEAS(cm)
65288D1	Double blister	6/24	16.6/15.6	49.5*28*38



65489D1

18pcs Short Arm Combo Hex Key Set



FEATURES:

- High Quality Chrome Vanadium Steel, guarantees an extremely tough cutting edge resistant to fracture and thus accident-proof life time 100% extend.
- Surface: tip bright chrome plating, color rubber coating.

CONTAINS:

- Metric: 1.5mm, 2mm, 2.5mm, 3mm, 4mm, 5mm, 6mm, 8mm, 10mm
- SAE: 1/16", 5/64", 3/32", 1/8", 5/32", 3/16", 1/4", 5/16", 3/8"

ITEM	Packaging	Box/carton	Gw/Nw(kg)	MEAS(cm)
65489D1	Double blister	6/24	16.6/15.6	49.5*28*38



65488D1

18pcs Short Arm Combo Hex Key Set



FEATURES:

- High Quality Chrome Vanadium Steel, guarantees an extremely tough cutting edge resistant to fracture and thus accident-proof life time 100% extend.
- Surface: tip bright chrome plating, color rubber coating.

CONTAINS:

- Metric: 1.5mm, 2mm, 2.5mm, 3mm, 4mm, 5mm, 6mm, 8mm, 10mm
- Torx: T10, T15, T20, T25, T27, T30, T40, T45, T50

ITEM	Packaging	Box/carton	Gw/Nw(kg)	MEAS(cm)
65488D1	Double blister	6/24	16.6/15.6	49.5*28*38



65487D1

18pcs Short Arm Combo Hex Key Set



FEATURES:

- High Quality Chrome Vanadium Steel, guarantees an extremely tough cutting edge resistant to fracture and thus accident-proof life time 100% extend.
- Surface: tip bright chrome plating, color rubber coating.

CONTAINS:

- SAE: 1/16", 5/64", 3/32", 1/8", 5/32", 3/16", 1/4", 5/16", 3/8"
- Torx: T10, T15, T20, T25, T27, T30, T40, T45, T50

ITEM	Packaging	Box/carton	Gw/Nw(kg)	MEAS(cm)
65487D1	Double blister	6/24	16.6/15.6	49.5*28*38

65289D2

18pcs Long Arm Combo Hex Key Set



FEATURES:

- High Quality Chrome Vanadium Steel, guarantees an extremely tough cutting edge resistant to fracture and thus accident-proof life time 100% extend.
- Surface: satin finish.

CONTAINS:

- Metric: 1.5mm, 2mm, 2.5mm, 3mm, 4mm, 5mm, 6mm, 8mm, 10mm
- SAE: 1/16", 5/64", 3/32", 1/8", 5/32", 3/16", 1/4", 5/16", 3/8"

ITEM	Packaging	Box/carton	Gw/Nw(kg)	MEAS(cm)
65289D2	Double blister	6/24	22/21	51*32.5*38.5



65287D2

18pcs Long Arm Combo Hex Key Set



FEATURES:

- High Quality Chrome Vanadium Steel, guarantees an extremely tough cutting edge resistant to fracture and thus accident-proof life time 100% extend.
- Surface: satin finish.

CONTAINS:

- SAE: 1/16", 5/64", 3/32", 1/8", 5/32", 3/16", 1/4", 5/16", 3/8"
- Torx: T10, T15, T20, T25, T27, T30, T40, T45, T50

ITEM	Packaging	Box/carton	Gw/Nw(kg)	MEAS(cm)
65287D2	Double blister	6/24	22/21	51*32.5*38.5



65489D2

18pcs Long Arm Combo Hex Key Set



FEATURES:

- High Quality Chrome Vanadium Steel, guarantees an extremely tough cutting edge resistant to fracture and thus accident-proof life time 100% extend.
- Surface: tip bright chrome plating, color rubber coating.

CONTAINS:

- Metric: 1.5mm, 2mm, 2.5mm, 3mm, 4mm, 5mm, 6mm, 8mm, 10mm
- SAE: 1/16", 5/64", 3/32", 1/8", 5/32", 3/16", 1/4", 5/16", 3/8"

ITEM	Packaging	Box/carton	Gw/Nw(kg)	MEAS(cm)
65489D2	Double blister	6/24	22/21	51*32.5*38.5

65488D2

18pcs Long Arm Combo Hex Key Set



FEATURES:

- High Quality Chrome Vanadium Steel, guarantees an extremely tough cutting edge resistant to fracture and thus accident-proof life time 100% extend.
- Surface: tip bright chrome plating, color rubber coating.

CONTAINS:

- Metric: 1.5mm, 2mm, 2.5mm, 3mm, 4mm, 5mm, 6mm, 8mm, 10mm
- Torx: T10, T15, T20, T25, T27, T30, T40, T45, T50

ITEM	Packaging	Box/carton	Gw/Nw(kg)	MEAS(cm)
65488D2	Double blister	6/24	22/21	51*32.5*38.5



TORX ★

The basic shape is a 6-pointed star formed with ear-lobular shaped curves. Compared to recessed hexagon heads, drive efficiency is higher as torque is smoothly and assuredly transmitted to screw while "CAM-OUT" is eliminated



TORX is a registered trademark of acument TM intellectual properties LLC(USA)

65487D2

18pcs Long Arm Combo Hex Key Set



FEATURES:

- High Quality Chrome Vanadium Steel, guarantees an extremely tough cutting edge resistant to fracture and thus accident-proof life time 100% extend.
- Surface: tip bright chrome plating, color rubber coating.

CONTAINS:

- SAE: 1/16", 5/64", 3/32", 1/8", 5/32", 3/16", 1/4", 5/16", 3/8"
- Torx: T10, T15, T20, T25, T27, T30, T40, T45, T50

ITEM	Packaging	Box/carton	Gw/Nw(kg)	MEAS(cm)
65287D2	Double blister	6/24	22/21	51*32.5*38.5

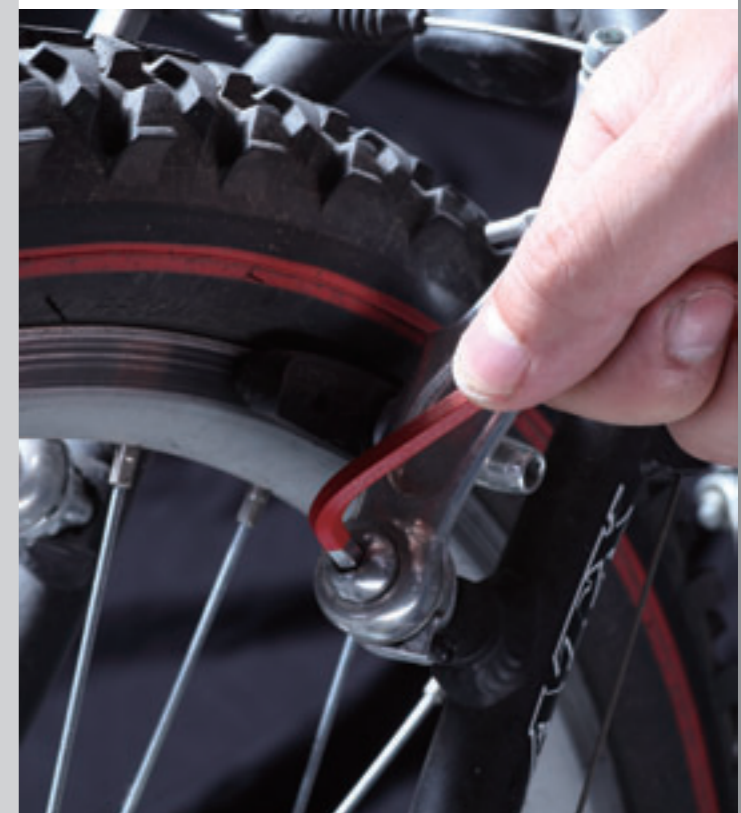

YJHK-221

8pcs Folding Hex Key Set



- FEATURES:
- Chrome vanadium steel for maximum performance.
 - Folding design, easy to carry.
 - Surface: black finish.

CONTAINS: • 1.5, 2, 2.5, 3, 4, 5, 6, 8mm

ITEM	Packaging	Box/carton	Gw/Nw(kg)	MEAS(cm)
YJHK-221E	Hanging Card	12/48	8/7	30.5*20*25

YJHK-222

9pcs Folding Hex Key Set



- FEATURES:
- Chrome vanadium steel for maximum performance.
 - Folding design, easy to carry.
 - Surface: black finish.

CONTAINS: • 5/64", 3/32", 7/64", 1/8", 9/64", 5/32", 3/16", 7/32", 1/4"

ITEM	Packaging	Box/carton	Gw/Nw(kg)	MEAS(cm)
YJHK-222E	Hanging Card	12/48	8/7	30.5*20*25

YJHK-223

8pcs Folding Torx Key Set



- FEATURES:
- Chrome vanadium steel for maximum performance.
 - Folding design, easy to carry.
 - Surface: black finish.

CONTAINS: • T9, T10, T15, T20, T25, T27, T30, T40

ITEM	Packaging	Box/carton	Gw/Nw(kg)	MEAS(cm)
YJHK-223E	Hanging Card	12/48	8/7	30.5*20*25



31317

17pcs Folding Hex Key Set



- FEATURES:
- Chrome vanadium steel for maximum performance.
 - Folding design, easy to carry.
 - Surface: black finish.

CONTAINS:

- Metric: 1.5, 2, 2.5, 3, 4, 5, 6, 8mm
- SAE: 5/64", 3/32", 7/64", 1/8", 9/64", 5/32", 3/16", 7/32", 1/4"

ITEM	Packaging	Box/carton	Gw/Nw(kg)	MEAS(cm)
31317E	Hanging Card	6/24	8.5/7.5	40*32*19

31318

16pcs Folding Hex Key Set



- FEATURES:
- Chrome vanadium steel for maximum performance.
 - Folding design, easy to carry.
 - Surface: black finish.

CONTAINS:

- Metric: 1.5, 2, 2.5, 3, 4, 5, 6, 8mm
- Torx: T9, T10, T15, T20, T25, T27, T30, T40

ITEM	Packaging	Box/carton	Gw/Nw(kg)	MEAS(cm)
31318E	Hanging Card	6/24	8.5/7.5	40*32*19

31319

17pcs Folding Hex Key Set



- FEATURES:
- Chrome vanadium steel for maximum performance.
 - Folding design, easy to carry.
 - Surface: black finish.

CONTAINS:

- SAE: 5/64", 3/32", 7/64", 1/8", 9/64", 5/32", 3/16", 7/32", 1/4"
- Torx: T9, T10, T15, T20, T25, T27, T30, T40

ITEM	Packaging	Box/carton	Gw/Nw(kg)	MEAS(cm)
31319E	Hanging Card	6/24	8.5/7.5	40*32*19

YJHK-2254

8pcs Folding Hex Key Set



- FEATURES:
- Chrome vanadium steel for maximum performance.
 - Folding design, easy to carry.
 - Surface: black finish.

CONTAINS: • 1.5, 2, 2.5, 3, 4, 5, 6, 8mm

ITEM	Packaging	Box/carton	Gw/Nw(kg)	MEAS(cm)
YJHK-2254E	Hanging Card	12/48	8/7	30.5*20*25

YJHK-2253

9pcs Folding Hex Key Set



- FEATURES:
- Chrome vanadium steel for maximum performance.
 - Folding design, easy to carry.
 - Surface: black finish.

CONTAINS: • 5/64", 3/32", 7/64", 1/8", 9/64", 5/32", 3/16", 7/32", 1/4"

ITEM	Packaging	Box/carton	Gw/Nw(kg)	MEAS(cm)
YJHK-2253E	Hanging Card	12/48	8/7	30.5*20*25

YJHK-2255

8pcs Folding Torx Key Set



- FEATURES:
- Chrome vanadium steel for maximum performance.
 - Folding design, easy to carry.
 - Surface: black finish.

CONTAINS: • T9, T10, T15, T20, T25, T27, T30, T40

ITEM	Packaging	Box/carton	Gw/Nw(kg)	MEAS(cm)
YJHK-2255E	Hanging Card	12/48	8/7	30.5*20*25

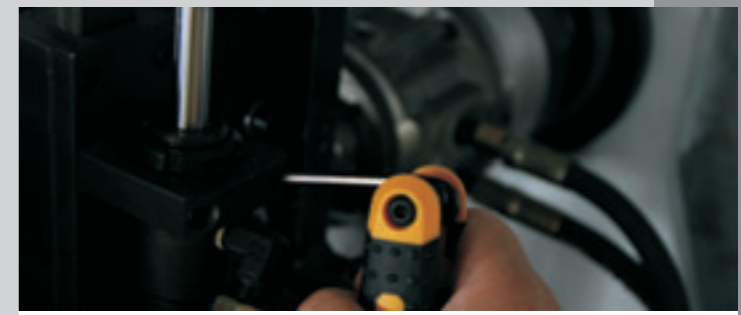

33317

17pcs Folding Hex Key Set



- FEATURES:
- Chrome vanadium steel for maximum performance.
 - Folding design, easy to carry.
 - Surface: black finish.

CONTAINS:

- Metric: 1.5, 2, 2.5, 3, 4, 5, 6, 8mm
- SAE: 5/64", 3/32", 7/64", 1/8", 9/64", 5/32", 3/16", 7/32", 1/4"

ITEM	Packaging	Box/carton	Gw/Nw(kg)	MEAS(cm)
33317E	Hanging Card	6/24	8.5/7.5	40*32*19

33318

16pcs Folding Hex Key Set



- FEATURES:
- Chrome vanadium steel for maximum performance.
 - Folding design, easy to carry.
 - Surface: black finish.

CONTAINS:

- Metric: 1.5, 2, 2.5, 3, 4, 5, 6, 8mm
- Torx: T9, T10, T15, T20, T25, T27, T30, T40

ITEM	Packaging	Box/carton	Gw/Nw(kg)	MEAS(cm)
33318E	Hanging Card	6/24	8.5/7.5	40*32*19

33319

17pcs Folding Hex Key Set



- FEATURES:
- Chrome vanadium steel for maximum performance.
 - Folding design, easy to carry.
 - Surface: black finish.

CONTAINS:

- SAE: 5/64", 3/32", 7/64", 1/8", 9/64", 5/32", 3/16", 7/32", 1/4"
- Torx: T9, T10, T15, T20, T25, T27, T30, T40

ITEM	Packaging	Box/carton	Gw/Nw(kg)	MEAS(cm)
33319E	Hanging Card	6/24	8.5/7.5	40*32*19





YJHK-217

8pcs Folding Hex Key Set



- FEATURES:
- Chrome vanadium steel for maximum performance.
 - Folding design, easy to carry.
 - Surface: satin finish.

CONTAINS: • 1.5, 2, 2.5, 3, 4, 5, 6, 8mm

ITEM	Packaging	Box/carton	Gw/Nw(kg)	MEAS(cm)
YJHK-217E	Hanging Card	12/48	12/11	30.5*26.5*26

YJHK-218

8pcs Folding Torx Key Set



- FEATURES:
- Chrome vanadium steel for maximum performance.
 - Folding design, easy to carry.
 - Surface: satin finish.

CONTAINS: • T9, T10, T15, T20, T25, T27, T30, T40

ITEM	Packaging	Box/carton	Gw/Nw(kg)	MEAS(cm)
YJHK-218E	Hanging Card	12/48	12/11	30.5*26.5*26

YJHK-219

9pcs Folding Hex Key Set



- FEATURES:
- Chrome vanadium steel for maximum performance.
 - Folding design, easy to carry.
 - Surface: satin finish.

CONTAINS: • 5/64", 3/32", 7/64", 1/8", 9/64", 5/32", 3/16", 7/32", 1/4"

ITEM	Packaging	Box/carton	Gw/Nw(kg)	MEAS(cm)
YJHK-219E	Hanging Card	12/48	12/11	30.5*26.5*26

YJHK-224

8pcs Folding Torx Key Set



- FEATURES:
- Chrome vanadium steel for maximum performance.
 - Folding design, easy to carry.
 - Surface: black finish.

CONTAINS: • T9, T10, T15, T20, T25, T27, T30, T40

ITEM	Packaging	Box/carton	Gw/Nw(kg)	MEAS(cm)
YJHK-224E	Hanging Card	10/100	16/15	27.5*25*38

YJHK-225

9pcs Folding Hex Key Set



- FEATURES:
- Chrome vanadium steel for maximum performance.
 - Folding design, easy to carry.
 - Surface: black finish.

CONTAINS: • 5/64", 3/32", 7/64", 1/8", 9/64", 5/32", 3/16", 7/32", 1/4"

ITEM	Packaging	Box/carton	Gw/Nw(kg)	MEAS(cm)
YJHK-225E	Hanging Card	10/100	16/15	27.5*25*38

YJHK-226

8pcs Folding Hex Key Set



- FEATURES:
- Chrome vanadium steel for maximum performance.
 - Folding design, easy to carry.
 - Surface: black finish.

CONTAINS: • 1.5, 2, 2.5, 3, 4, 5, 6, 8mm

ITEM	Packaging	Box/carton	Gw/Nw(kg)	MEAS(cm)
YJHK-226E	Hanging Card	10/100	16/15	27.5*25*38

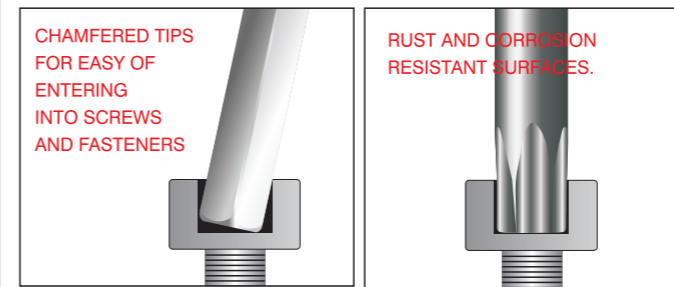

34211

8pcs Folding Hex Key Set

Big handle



- FEATURES:
- Chrome vanadium steel for maximum performance.
 - Top quality design.
 - Big frame size: 35x130x40mm

CONTAINS: • 1.5, 2, 2.5, 3, 4, 5, 6, 8mm

ITEM	Packaging	Box/carton	Gw/Nw(kg)	MEAS(cm)
34211E	Hanging Card	6/24	5.3/4.3	28.5*22*27

34212

9pcs Folding Hex Key Set

Big handle



- FEATURES:
- Chrome vanadium steel for maximum performance.
 - Top quality design.
 - Big frame size: 35x130x40mm

CONTAINS: • 5/64", 3/32", 7/64", 1/8", 9/64", 5/32", 3/16", 7/32", 1/4"

ITEM	Packaging	Box/carton	Gw/Nw(kg)	MEAS(cm)
34212E	Hanging Card	6/24	5.3/4.3	28.5*22*27

34233

8pcs Folding Torx Key Set

Big handle



- FEATURES:
- Chrome vanadium steel for maximum performance.
 - Top quality design.
 - Big frame size: 35x130x40mm

CONTAINS: • T9, T10, T15, T20, T25, T27, T30, T40

ITEM	Packaging	Box/carton	Gw/Nw(kg)	MEAS(cm)
34233E	Hanging Card	6/24	5.3/4.3	28.5*22*27

34216

6pcs Folding Hex Key Set

Small handle



- FEATURES:
- Chrome vanadium steel for maximum performance.
 - Top quality design.
 - Small frame size: 118x35x30mm

CONTAINS: • 2, 2.5, 3, 4, 5, 6mm

ITEM	Packaging	Box/carton	Gw/Nw(kg)	MEAS(cm)
34216E	Hanging Card	6/24	3.8/2.8	28.5*21*25

34226

7pcs Folding Hex Key Set

Small handle



- FEATURES:
- Chrome vanadium steel for maximum performance.
 - Top quality design.
 - Small frame size: 118x35x30mm

CONTAINS: • 3/32", 7/64", 1/8", 9/64", 5/32", 3/16", 7/32"

ITEM	Packaging	Box/carton	Gw/Nw(kg)	MEAS(cm)
34226E	Hanging Card	6/24	3.8/2.8	28.5*21*25

34236

6pcs Folding Torx Key Set

Small handle



- FEATURES:
- Chrome vanadium steel for maximum performance.
 - Top quality design.
 - Small frame size: 118x35x30mm

CONTAINS: • T10, T15, T20, T25, T27, T30

ITEM	Packaging	Box/carton	Gw/Nw(kg)	MEAS(cm)
34236E	Hanging Card	6/24	3.8/2.8	28.5*21*25



34283

17pcs Folding Hex Key Set



- FEATURES:**
- Chrome vanadium steel for maximum performance.
 - Top quality design.
 - Big frame size: 35x130x40mm

- CONTAINS:**
- Metric: 1.5, 2, 2.5, 3, 4, 5, 6, 8mm
 - SAE: 5/64", 3/32", 7/64", 1/8", 9/64", 5/32", 3/16", 7/32", 1/4"

ITEM	Packaging	Box/carton	Gw/Nw(kg)	MEAS(cm)
34283D	Double blister	10/40	17.5/16.5	50*26.5*41.5

34284

16pcs Folding Hex Key Set



- FEATURES:**
- Chrome vanadium steel for maximum performance.
 - Top quality design.
 - Big frame size: 35x130x40mm

- CONTAINS:**
- Metric: 1.5, 2, 2.5, 3, 4, 5, 6, 8mm
 - Torx: T9, T10, T15, T20, T25, T27, T30, T40

ITEM	Packaging	Box/carton	Gw/Nw(kg)	MEAS(cm)
34284D	Double blister	10/40	17.5/16.5	50*26.5*41.5

34285

17pcs Folding Hex Key Set



- FEATURES:**
- Chrome vanadium steel for maximum performance.
 - Top quality design.
 - Big frame size: 35x130x40mm

- CONTAINS:**
- SAE: 5/64", 3/32", 7/64", 1/8", 9/64", 5/32", 3/16", 7/32", 1/4"
 - Torx: T9, T10, T15, T20, T25, T27, T30, T40

ITEM	Packaging	Box/carton	Gw/Nw(kg)	MEAS(cm)
34285D	Double blister	10/40	17.5/16.5	50*26.5*41.5



YJHK-504

3PK Folding Hex Key Set



- FEATURES:**
- Chrome vanadium steel for maximum performance.
 - Folding design, easy to carry.
 - Surface: satin finish.

- CONTAINS:**
- Metric: 1.5, 2, 2.5, 3, 4, 5, 6, 8mm
 - SAE: 5/64", 3/32", 7/64", 1/8", 9/64", 5/32", 3/16", 7/32", 1/4"
 - Torx: T9, T10, T15, T20, T25, T27, T30, T40

ITEM	Packaging	Box/carton	Gw/Nw(kg)	MEAS(cm)
YJHK-504E	Hanging Card	8/32	12/11	38.5*25*35.5

YJHK-227

3PK Folding Hex Key Set



- FEATURES:**
- Chrome vanadium steel for maximum performance.
 - Folding design, easy to carry.
 - Surface: satin finish.

- CONTAINS:**
- Metric: 1.5, 2, 2.5, 3, 4, 5, 6, 8mm
 - SAE: 5/64", 3/32", 7/64", 1/8", 9/64", 5/32", 3/16", 7/32", 1/4"
 - Torx: T9, T10, T15, T20, T25, T27, T30, T40

ITEM	Packaging	Box/carton	Gw/Nw(kg)	MEAS(cm)
YJHK-227E	Hanging Card	6/24	12.8/11.8	60.5*36*27.5

YJHK-562

3PK Aluminium Folding Hex Key Set



- FEATURES:**
- Chrome vanadium steel for maximum performance.
 - Folding design, easy to carry.
 - Surface: satin finish.

- CONTAINS:**
- Metric: 1.5, 2, 2.5, 3, 4, 5, 6mm
 - SAE: 1/16", 5/64", 3/32", 7/64", 1/8", 9/64", 5/32, 3/16", 1/4"
 - Torx: T6, T7, T8, T9, T10, T15, T20, T25

ITEM	Packaging	Box/carton	Gw/Nw(kg)	MEAS(cm)
YJHK-562D	Double blister	8/32	10.6/9.6	38.5*28*37.5

YJHK-568

3PK Aluminium Folding Hex Key Set



- FEATURES:**
- Chrome vanadium steel for maximum performance.
 - Folding design, easy to carry.
 - Surface: satin finish.

- CONTAINS:**
- Metric: 1.5, 2, 2.5, 3, 4, 5, 6mm
 - SAE: 1/16", 5/64", 3/32", 7/64", 1/8", 9/64", 5/32, 3/16", 1/4"
 - Torx: T6, T7, T8, T9, T10, T15, T20, T25

ITEM	Packaging	Box/carton	Gw/Nw(kg)	MEAS(cm)
YJHK-568D	Double blister	8/32	10.6/9.6	38.5*28*37.5

TORX ★

The basic shape is a 6-pointed star formed with ear-lobular shaped curves. Compared to recessed hexagon heads, drive efficiency is higher as torque is smoothly and assuredly transmitted to screw while "CAM-OUT" is eliminated



TORX is a registered trademark of acument TM intellectual properties LLC(USA)



YJHK-563

3PK Aluminium Folding Hex Key Set



- FEATURES:**
- Chrome vanadium steel for maximum performance.
 - Folding design, easy to carry.
 - Surface: satin finish.

- CONTAINS:**
- Metric: 1.5, 2, 2.5, 3, 4, 5, 6, 8mm
 - SAE: 5/64", 3/32", 7/64", 1/8", 9/64", 5/32", 3/16", 7/32", 1/4"
 - Torx: T9, T10, T15, T20, T25, T27, T30, T40

ITEM	Packaging	Box/carton	Gw/Nw(kg)	MEAS(cm)
YJHK-563D	Double blister	6/24	17/16	40*30.5*27.5

YJHK-566

3PK Aluminium Folding Hex Key Set



- FEATURES:**
- Chrome vanadium steel for maximum performance.
 - Folding design, easy to carry.
 - Surface: satin finish.

- CONTAINS:**
- Metric: 1.5, 2, 2.5, 3, 4, 5, 6, 8mm
 - SAE: 5/64", 3/32", 7/64", 1/8", 9/64", 5/32", 3/16", 7/32", 1/4"
 - Torx: T9, T10, T15, T20, T25, T27, T30, T40

ITEM	Packaging	Box/carton	Gw/Nw(kg)	MEAS(cm)
YJHK-566D	Double blister	6/24	17/16	40*30.5*27.5

YJHK-510

8pcs Aluminium Folding Hex Key Set

Big handle



- FEATURES:
- Chrome vanadium steel for maximum performance.
 - Folding design, easy to carry.
 - Surface: color anodized aluminium frame, satin chrome plating shaft.

CONTAINS: • 1.5, 2, 2.5, 3, 4, 5, 6, 8mm

ITEM	Packaging	Box/carton	Gw/Nw(kg)	MEAS(cm)
YJHK-510E	Hanging Card	12/72	13/12	43.5*23*23

YJHK-511

9pcs Aluminium Folding Hex Key Set

Big handle



- FEATURES:
- Chrome vanadium steel for maximum performance.
 - Folding design, easy to carry.
 - Surface: color anodized aluminium frame, satin chrome plating shaft.

CONTAINS: • 5/64", 3/32", 7/64", 1/8", 9/64", 5/32", 3/16", 7/32", 1/4"

ITEM	Packaging	Box/carton	Gw/Nw(kg)	MEAS(cm)
YJHK-511E	Hanging Card	12/72	13/12	43.5*23*23

YJHK-512

8pcs Aluminium Folding Torx Key Set

Big handle



- FEATURES:
- Chrome vanadium steel for maximum performance.
 - Folding design, easy to carry.
 - Surface: color anodized aluminium frame, satin chrome plating shaft.

CONTAINS: • T9, T10, T15, T20, T25, T27, T30, T40

ITEM	Packaging	Box/carton	Gw/Nw(kg)	MEAS(cm)
YJHK-512E	Hanging Card	12/72	13/12	43.5*23*23



YJHK-536

7pcs Aluminium Folding Hex Key Set

Small handle



- FEATURES:
- Chrome vanadium steel for maximum performance.
 - Folding design, easy to carry.
 - Surface: color anodized aluminium frame, satin chrome plating shaft.

CONTAINS: • 1.5, 2, 2.5, 3, 4, 5, 6mm

ITEM	Packaging	Box/carton	Gw/Nw(kg)	MEAS(cm)
YJHK-536E	Hanging Card	12/72	10/9	37.5*27.5*25

YJHK-537

9pcs Aluminium Folding Hex Key Set

Small handle



- FEATURES:
- Chrome vanadium steel for maximum performance.
 - Folding design, easy to carry.
 - Surface: color anodized aluminium frame, satin chrome plating shaft.

CONTAINS: • 1/16", 5/64", 3/32", 7/64", 1/8", 9/64", 5/32", 3/16", 1/4"

ITEM	Packaging	Box/carton	Gw/Nw(kg)	MEAS(cm)
YJHK-537E	Hanging Card	12/72	10/9	37.5*27.5*25

YJHK-538

8pcs Aluminium Folding Torx Key Set

Small handle



- FEATURES:
- Chrome vanadium steel for maximum performance.
 - Folding design, easy to carry.
 - Surface: color anodized aluminium frame, satin chrome plating shaft.

CONTAINS: • T6, T7, T8, T9, T10, T15, T20, T25

ITEM	Packaging	Box/carton	Gw/Nw(kg)	MEAS(cm)
YJHK-538E	Hanging Card	12/72	10/9	37.5*27.5*25

YJHK-515

8pcs Aluminium Folding Hex Key Set

Big handle



- FEATURES:
- Chrome vanadium steel for maximum performance.
 - Folding design, easy to carry.
 - Surface: color anodized aluminium frame, satin chrome plating shaft.

CONTAINS: • 1.5, 2, 2.5, 3, 4, 5, 6, 8mm

ITEM	Packaging	Box/carton	Gw/Nw(kg)	MEAS(cm)
YJHK-515E	Hanging Card	12/72	8.6/7.6	42.5*22.5*20

YJHK-516

9pcs Aluminium Folding Hex Key Set

Big handle



- FEATURES:
- Chrome vanadium steel for maximum performance.
 - Folding design, easy to carry.
 - Surface: color anodized aluminium frame, satin chrome plating shaft.

CONTAINS: • 5/64", 3/32", 7/64", 1/8", 9/64", 5/32", 3/16", 7/32", 1/4"

ITEM	Packaging	Box/carton	Gw/Nw(kg)	MEAS(cm)
YJHK-516E	Hanging Card	12/72	8.6/7.6	42.5*22.5*20

YJHK-517

8pcs Aluminium Folding Torx Key Set

Big handle



- FEATURES:
- Chrome vanadium steel for maximum performance.
 - Folding design, easy to carry.
 - Surface: color anodized aluminium frame, satin chrome plating shaft.

CONTAINS: • T8, T9, T10, T15, T20, T25, T27, T30

ITEM	Packaging	Box/carton	Gw/Nw(kg)	MEAS(cm)
YJHK-517E	Hanging Card	12/72	8.6/7.6	42.5*22.5*20



YJHK-518

7pcs Aluminium Folding Hex Key Set

Small handle



- FEATURES:
- Chrome vanadium steel for maximum performance.
 - Folding design, easy to carry.
 - Surface: color anodized aluminium frame, satin chrome plating shaft.

CONTAINS: • 1.5, 2, 2.5, 3, 4, 5, 6mm

ITEM	Packaging	Box/carton	Gw/Nw(kg)	MEAS(cm)
YJHK-518E	Hanging Card	12/72	8/7	42.5*22.5*20

YJHK-519

9pcs Aluminium Folding Hex Key Set

Small handle



- FEATURES:
- Chrome vanadium steel for maximum performance.
 - Folding design, easy to carry.
 - Surface: color anodized aluminium frame, satin chrome plating shaft.

CONTAINS: • 1/16", 5/64", 3/32", 7/64", 1/8", 9/64", 5/32", 3/16", 1/4"

ITEM	Packaging	Box/carton	Gw/Nw(kg)	MEAS(cm)
YJHK-519E	Hanging Card	12/72	8/7	42.5*22.5*20

YJHK-520

8pcs Aluminium Folding Torx Key Set

Small handle



- FEATURES:
- Chrome vanadium steel for maximum performance.
 - Folding design, easy to carry.
 - Surface: color anodized aluminium frame, satin chrome plating shaft.

CONTAINS: • T6, T7, T8, T9, T10, T15, T20, T25

ITEM	Packaging	Box/carton	Gw/Nw(kg)	MEAS(cm)
YJHK-520E	Hanging Card	12/72	8/7	42.5*22.5*20

17201**8pcs Aluminium Folding Hex Key Set**

Big handle



- FEATURES:
- Chrome vanadium steel for maximum performance.
 - Folding design, easy to carry.
 - Surface: color anodized aluminium frame, satin chrome plating shaft.

CONTAINS: • 1.5, 2, 2.5, 3, 4, 5, 6, 8mm

ITEM	Packaging	Box/carton	Gw/Nw(kg)	MEAS(cm)
17201E	Hanging Card	12/72		43.5*24.5*20

17202**9pcs Aluminium Folding Hex Key Set**

Big handle



- FEATURES:
- Chrome vanadium steel for maximum performance.
 - Folding design, easy to carry.
 - Surface: color anodized aluminium frame, satin chrome plating shaft.

CONTAINS: • 5/64", 3/32", 7/64", 1/8", 9/64", 5/32", 3/16", 7/32", 1/4"

ITEM	Packaging	Box/carton	Gw/Nw(kg)	MEAS(cm)
17202E	Hanging Card	12/72		43.5*24.5*20

17223**8pcs Aluminium Folding Torx Key Set**

Big handle



- FEATURES:
- Chrome vanadium steel for maximum performance.
 - Folding design, easy to carry.
 - Surface: color anodized aluminium frame, satin chrome plating shaft.

CONTAINS: • T8, T10, T15, T20, T25, T27, T30, T40

ITEM	Packaging	Box/carton	Gw/Nw(kg)	MEAS(cm)
17223E	Hanging Card	12/72		43.5*24.5*20

**17127****7pcs Aluminium Folding Hex Key Set**

Small handle



- FEATURES:
- Chrome vanadium steel for maximum performance.
 - Folding design, easy to carry.
 - Surface: color anodized aluminium frame, satin chrome plating shaft.

CONTAINS: • 1.5, 2, 2.5, 3, 4, 5, 6mm

ITEM	Packaging	Box/carton	Gw/Nw(kg)	MEAS(cm)
17127E	Hanging Card	12/72		43.5*24.5*20

17128**8pcs Aluminium Folding Hex Key Set**

Small handle



- FEATURES:
- Chrome vanadium steel for maximum performance.
 - Folding design, easy to carry.
 - Surface: color anodized aluminium frame, satin chrome plating shaft.

CONTAINS: • 1/16", 5/64", 3/32", 1/8", 5/32", 3/16", 7/32", 1/4"

ITEM	Packaging	Box/carton	Gw/Nw(kg)	MEAS(cm)
17128E	Hanging Card	12/72		43.5*24.5*20

17138**7pcs Aluminium Folding Torx Key Set**

Small handle



- FEATURES:
- Chrome vanadium steel for maximum performance.
 - Folding design, easy to carry.
 - Surface: color anodized aluminium frame, satin chrome plating shaft.

CONTAINS: • T8, T10, T15, T20, T25, T27, T30

ITEM	Packaging	Box/carton	Gw/Nw(kg)	MEAS(cm)
17138E	Hanging Card	12/72		43.5*24.5*20

YJHK-526**8pcs Aluminium Folding Hex Key Set**

Big handle



- FEATURES:
- Chrome vanadium steel for maximum performance.
 - Folding design, easy to carry.
 - Surface: color anodized aluminium frame, satin chrome plating shaft.

CONTAINS: • 1.5, 2, 2.5, 3, 4, 5, 6, 8mm

ITEM	Packaging	Box/carton	Gw/Nw(kg)	MEAS(cm)
YJHK-526E	Hanging Card	12/72	11.8/10.8	43.5*23*23

YJHK-527**9pcs Aluminium Folding Hex Key Set**

Big handle



- FEATURES:
- Chrome vanadium steel for maximum performance.
 - Folding design, easy to carry.
 - Surface: color anodized aluminium frame, satin chrome plating shaft.

CONTAINS: • 5/64", 3/32", 7/64", 1/8", 9/64", 5/32", 3/16", 7/32", 1/4"

ITEM	Packaging	Box/carton	Gw/Nw(kg)	MEAS(cm)
YJHK-527E	Hanging Card	12/72	11.8/10.8	43.5*23*23

YJHK-528**8pcs Aluminium Folding Torx Key Set**

Big handle



- FEATURES:
- Chrome vanadium steel for maximum performance.
 - Folding design, easy to carry.
 - Surface: color anodized aluminium frame, satin chrome plating shaft.

CONTAINS: • T8, T9, T10, T15, T20, T25, T27, T30

ITEM	Packaging	Box/carton	Gw/Nw(kg)	MEAS(cm)
YJHK-528E	Hanging Card	12/72	11.8/10.8	43.5*23*23

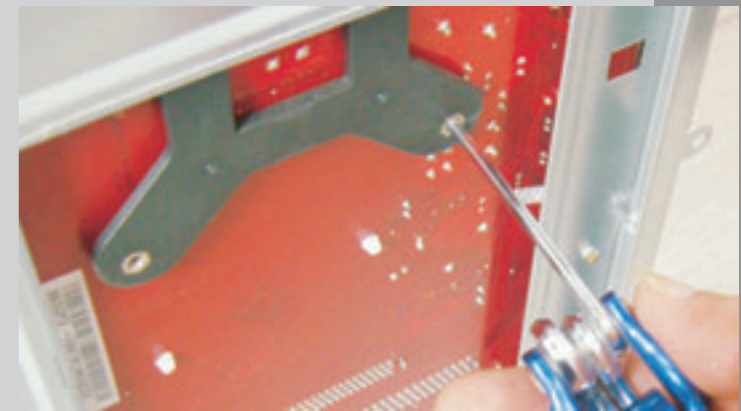
**YJHK-529****7pcs Aluminium Folding Hex Key Set**

Small handle



- FEATURES:
- Chrome vanadium steel for maximum performance.
 - Folding design, easy to carry.
 - Surface: color anodized aluminium frame, satin chrome plating shaft.

CONTAINS: • 1.5, 2, 2.5, 3, 4, 5, 6mm

ITEM	Packaging	Box/carton	Gw/Nw(kg)	MEAS(cm)
YJHK-529E	Hanging Card	12/72	9/8	37.5*27.5*25

YJHK-530**9pcs Aluminium Folding Hex Key Set**

Small handle



- FEATURES:
- Chrome vanadium steel for maximum performance.
 - Folding design, easy to carry.
 - Surface: color anodized aluminium frame, satin chrome plating shaft.

CONTAINS: • 1/16", 5/64", 3/32", 7/64", 1/8", 9/64", 5/32", 3/16", 1/4"

ITEM	Packaging	Box/carton	Gw/Nw(kg)	MEAS(cm)
YJHK-530E	Hanging Card	12/72	9/8	37.5*27.5*25

YJHK-531**8pcs Aluminium Folding Torx Key Set**

Small handle



- FEATURES:
- Chrome vanadium steel for maximum performance.
 - Folding design, easy to carry.
 - Surface: color anodized aluminium frame, satin chrome plating shaft.

CONTAINS: • T6, T7, T8, T9, T10, T15, T20, T25

ITEM	Packaging	Box/carton	Gw/Nw(kg)	MEAS(cm)
YJHK-531E	Hanging Card	12/72	9/8	37.5*27.5*25



YJHK-521

7pcs Aluminium Folding Hex Key Set



- FEATURES:
- Chrome vanadium steel for maximum performance.
 - Folding design, easy to carry.
 - Surface: color anodized aluminium frame, satin chrome plating shaft.

CONTAINS: • 1.5, 2, 2.5, 3, 4, 5, 6mm

ITEM	Packaging	Box/carton	Gw/Nw(kg)	MEAS(cm)
YJHK-521E	Hanging Card	12/72	8/7	42.5*22.5*20

YJHK-522

9pcs Aluminium Folding Hex Key Set



- FEATURES:
- Chrome vanadium steel for maximum performance.
 - Folding design, easy to carry.
 - Surface: color anodized aluminium frame, satin chrome plating shaft.

CONTAINS: • 5/64", 3/32", 7/64", 1/8", 9/64", 5/32", 3/16", 7/32", 1/4"

ITEM	Packaging	Box/carton	Gw/Nw(kg)	MEAS(cm)
YJHK-522E	Hanging Card	12/72	8/7	42.5*22.5*20

YJHK-523

8pcs Aluminium Folding Torx Key Set



- FEATURES:
- Chrome vanadium steel for maximum performance.
 - Folding design, easy to carry.
 - Surface: color anodized aluminium frame, satin chrome plating shaft.

CONTAINS: • T8, T9, T10, T15, T20, T25, T27, T30

ITEM	Packaging	Box/carton	Gw/Nw(kg)	MEAS(cm)
YJHK-523E	Hanging Card	12/72	8/7	42.5*22.5*20

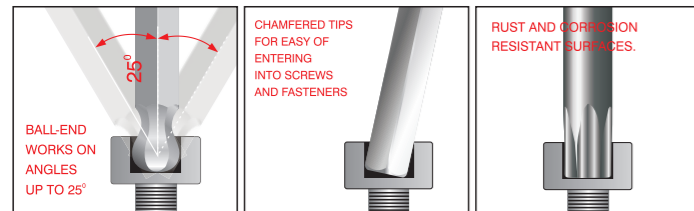

YJHK-524

6pc Aluminium Folding Screwdriver Set



- FEATURES:
- Chrome vanadium steel for maximum performance.
 - Folding design, easy to carry.
 - Surface: color anodized aluminium frame, satin chrome plating shaft.

CONTAINS: • phillips: PH0, PH1, PH2; slotted: 3, 4, 5mm

ITEM	Packaging	Box/carton	Gw/Nw(kg)	MEAS(cm)
YJHK-524E	Hanging Card	12/72	8/7	42.5*22.5*20

YJHK-525

6pc Aluminium Folding Screwdriver Set



- FEATURES:
- Chrome vanadium steel for maximum performance.
 - Folding design, easy to carry.
 - Surface: color anodized aluminium frame, satin chrome plating shaft.

CONTAINS: • phillips: PH0, PH1, PH2; slotted: 1/8", 5/32", 1/4"

ITEM	Packaging	Box/carton	Gw/Nw(kg)	MEAS(cm)
YJHK-525E	Hanging Card	12/72	8/7	42.5*22.5*20

18201

8pcs Aluminium Folding Hex Key Set



- FEATURES:
- Chrome vanadium steel for maximum performance.
 - Folding design, easy to carry.
 - Surface: color anodized aluminium frame, satin chrome plating shaft.

CONTAINS: • 1.5, 2, 2.5, 3, 4, 5, 6, 8mm

ITEM	Packaging	Box/carton	Gw/Nw(kg)	MEAS(cm)
18201E	Hanging Card	12/72		43.5*24.5*20

18202

9pcs Aluminium Folding Hex Key Set



- FEATURES:
- Chrome vanadium steel for maximum performance.
 - Folding design, easy to carry.
 - Surface: color anodized aluminium frame, satin chrome plating shaft.

CONTAINS: • 5/64", 3/32", 7/64", 1/8", 9/64", 5/32", 3/16", 7/32", 1/4"

ITEM	Packaging	Box/carton	Gw/Nw(kg)	MEAS(cm)
18202E	Hanging Card	12/72		43.5*24.5*20

18223

8pcs Aluminium Folding Torx Key Set



- FEATURES:
- Chrome vanadium steel for maximum performance.
 - Folding design, easy to carry.
 - Surface: color anodized aluminium frame, satin chrome plating shaft.

CONTAINS: • T8, T10, T15, T20, T25, T27, T30, T40

ITEM	Packaging	Box/carton	Gw/Nw(kg)	MEAS(cm)
18223	Hanging Card	12/72		43.5*24.5*20

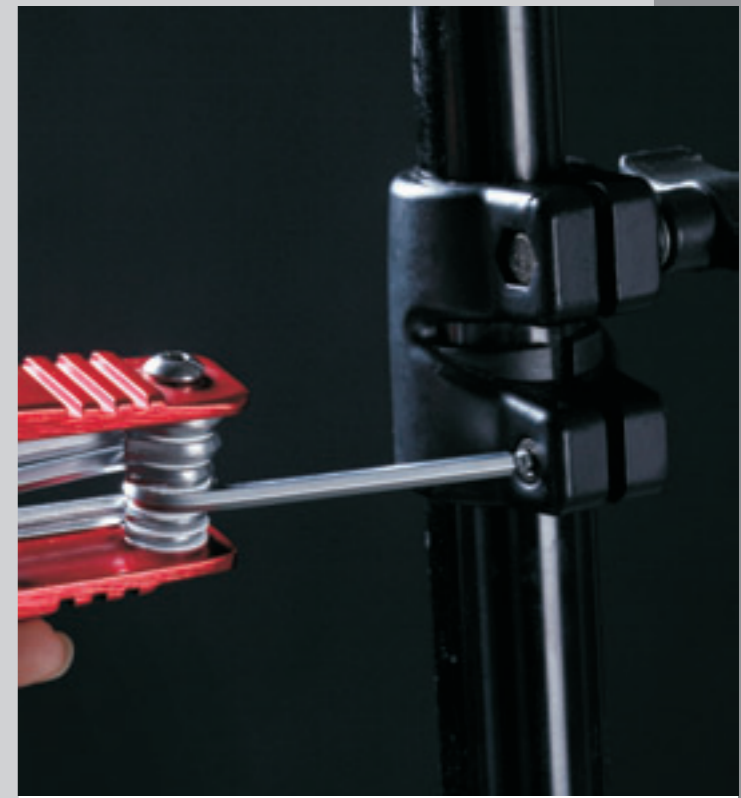
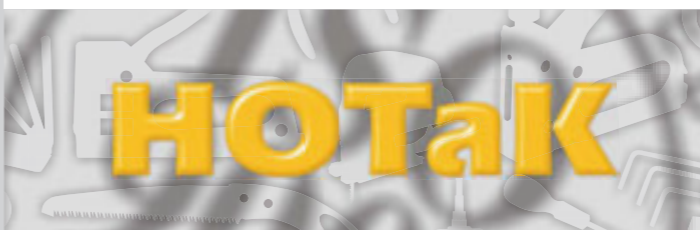

16103

12pcs Socket & Screwdriver Bits Set



- FEATURES:
- Chrome vanadium steel for maximum performance.
 - Folding design, easy to carry.
 - Surface: color anodized aluminium frame, satin chrome plating shaft.

CONTAINS: • 4pcs socket: 6, 8, 9, 10mm;
4pcs phillips: PH0, PH1, PH2, PH3;
3pcs slotted: 3, 4, 5mm;
1pc socket adapter

ITEM	Packaging	Box/carton	Gw/Nw(kg)	MEAS(cm)
16103D	Hanging Card	6/24	7.4/6.4	37.5*29.5*44.5





YJHK-232

8pc Folding Hex Key Set



- FEATURES:
- Chrome vanadium steel for maximum performance
 - Folds securely into convenient metal storage compartment
 - Top quality design
 - Surface: chrome finish

CONTAINS: • 3/32", 1/8", 5/32", 3/16", 7/32", 1/4", 5/16", 3/8"

YJHK-231

8pc Folding Hex Key Set



- FEATURES:
- Chrome vanadium steel for maximum performance
 - Folds securely into convenient metal storage compartment
 - Top quality design
 - Surface: chrome finish

CONTAINS: • 2.5, 3, 4, 5, 6, 7, 8, 10mm

YJHK-230

7pc Folding Torx Key Set



- FEATURES:
- Chrome vanadium steel for maximum performance
 - Folds securely into convenient metal storage compartment
 - Top quality design
 - Surface: chrome finish

CONTAINS: • T10, T15, T20, T25, T27, T30, T40

YJHK-237

8pcs Hex Key Set On Ring



- FEATURES:
- Chrome vanadium steel for maximum performance.
 - Heat treated for hardness more than HRC52.
 - Surface: black finish.

CONTAINS: • 1.5, 2, 2.5, 3, 4, 5, 5.5, 6mm

YJHK-238

8pcs Hex Key Set On Ring



- FEATURES:
- Chrome vanadium steel for maximum performance.
 - Heat treated for hardness more than HRC52.
 - Surface: chrome finish.

CONTAINS: • 1.5, 2, 2.5, 3, 4, 5, 5.5, 6mm

YJHK-239

10pcs Hex Key Set On Ring



- FEATURES:
- Chrome vanadium steel for maximum performance.
 - Heat treated for hardness more than HRC52.
 - Surface: chrome finish.

CONTAINS: • 1.5, 2, 2.5, 3, 4, 5, 5.5, 6, 8, 10mm

YJHK-240

10pcs Hex Key Set On Ring



- FEATURES:
- Chrome vanadium steel for maximum performance.
 - Heat treated for hardness more than HRC52.
 - Surface: chrome finish.

CONTAINS: • 1/16", 5/64", 3/32", 1/8", 5/32", 3/16", 7/32", 1/4", 5/16", 3/8"



YJHK-342

16pcs T-handle Hex key Wrench Set



- FEATURES:
- High quality Chrome Vanadium Steel.
 - Dual color handle PP/TPR.
 - Thick neck design provides super torque strength.
 - Surface: satin finish.

CONTAINS: • Metric: 2, 2.5, 3, 4, 5, 6, 8, 10mm
• SAE: 5/32", 3/32", 1/8", 5/32", 3/16", 1/4", 5/16", 3/8"

YJHK-343

16pcs T-handle Hex key Wrench Set



- FEATURES:
- High quality Chrome Vanadium Steel.
 - Dual color handle PP/TPR.
 - Thick neck design provides super torque strength.
 - Surface: satin finish.

CONTAINS: • Metric: 2, 2.5, 3, 4, 5, 6, 8, 10mm
• Torx: T10, T15, T20, T25, T30, T40, T45, T50

YJHK-344

16pcs T-handle Hex key Wrench Set



- FEATURES:
- High quality Chrome Vanadium Steel.
 - Dual color handle PP/TPR.
 - Thick neck design provides super torque strength.
 - Surface: satin finish.

CONTAINS: • SAE: 5/32", 3/32", 1/8", 5/32", 3/16", 1/4", 5/16", 3/8"
• Torx: T10, T15, T20, T25, T30, T40, T45, T50

YJHK-650

10pcs T-handle Hex Key Set



- FEATURES:
- High quality Chrome Vanadium Steel.
 - Thick neck design provides super torque strength.
 - Surface: black finish.

CONTAINS: • 2.0, 2.5, 3.0, 4.0, 4.5, 5.0, 5.5, 6.0, 8.0, 10.0mm

ITEM	Packaging	Box/carton	Gw/Nw(kg)	MEAS(cm)
YJHK-650W	Color box	5/12	9/8.5	40.5*30.5*33

YJHK-651

10pcs T-handle Hex Key Set



- FEATURES:
- High quality Chrome Vanadium Steel.
 - Thick neck design provides super torque strength.
 - Surface: black finish.

CONTAINS: • 3/32", 7/64", 1/8", 9/64", 5/32", 3/16", 7/32", 1/4", 5/16", 3/8"

ITEM	Packaging	Box/carton	Gw/Nw(kg)	MEAS(cm)
YJHK-651W	Color box	5/12	9/8.5	40.5*30.5*33

YJHK-2505

10pcs T-handle Hex Key Set



- FEATURES:
- High quality Chrome Vanadium Steel.
 - Thick neck design provides super torque strength.
 - Surface: black finish.

CONTAINS: • Metric: 1.5, 2, 2.5, 3, 4, 5, 6, 8, 10mm
• SAE: 1/16", 5/64", 3/32", 1/8", 5/32", 3/16", 1/4", 5/16", 3/8"

PRECISION SCREWDRIVER

HOMATER precision screwdrivers could be your best choice of repair work such as home, office, automotive, electronics, hardware, crafts, hobby, etc...

Precision screwdriver is one of our earliest products with 20 years of production history and experience. From the iron handle to the aluminum and dual-color plastic handle, and equipped with many style of plastic boxes to form different screwdriver sets. more types make customers have more choices.

HOTaK

The material of precision screwdriver is CR-V, this kind of alloy steel can make the screwdrivers head more accurate and durable.

Accurate head specifications and craft ship can make you work more easier.

Homaster screwdrivers with excellent quality, mature process and fashionable appearance, has established a good brand image in the industry.

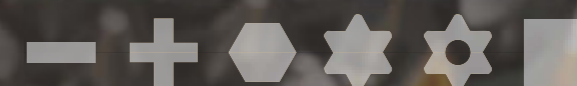

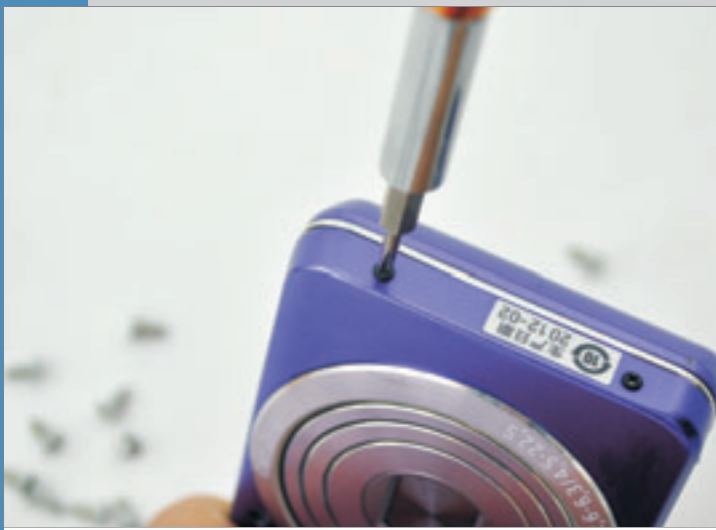

YJPS-6665

18pcs Smart Phone Repair Kit



FEATURES:

- Ideal for repairing mobile phone, glasses, camera, computer etc.
- Ergonomic bit driver for better grip.
- Bits of chrome vanadium steel.

CONTAINS:

- 1pc dual color soft grip screwdriver handle.
- 1pc 120mm magnetic extension shaft.
- 1pc suction cup
- 1pc mini pry bar
- 14pc precision bits:
 - 1pc triangle: 2.0mm
 - 2pc five pointed star bit: 0.8, 2.0mm
 - 2pc phillips: PH000, PH00
 - 3pc slotted: 1.5, 2.0, 2.5mm
 - 6pc torx: T4, T5, T6, T7, T8, T10



YJPS-6666

7pcs Precision Screwdriver Set



FEATURES:

- Ergonomic bit driver for better grip.
- Bits of chrome vanadium steel.
- Aluminum handle for better performance.

CONTAINS:

- 1pc aluminum screwdriver handle
- 1pc 3X magnifier.
- 5pc precision bits:
 - 3pc phillips: PH000, PH00, PH0
 - 2pc slotted: 1.5, 2.0mm

YJPS-6667

8pcs Precision Screwdriver Set



FEATURES:

- Ergonomic bit driver for better grip.
- Bits of chrome vanadium steel.
- Aluminum handle for better performance.

CONTAINS:

- 1pc aluminum screwdriver handle
- 1pc suction cup
- 1pc mini pry bar
- 5pc precision bits:
 - 1pc five pointed star bit: 0.8mm
 - 1pc phillips: PH000
 - 1pc slotted: 2.0mm
 - 2pc torx: T5, T6

YJPS-6668

8pcs Precision Screwdriver Set



FEATURES:

- Ideal for repairing mobile phone, glasses, camera, computer etc.
- Aluminum handle for better performance.
- Bits of chrome vanadium steel.

CONTAINS:

- 1pc aluminum screwdriver handle
- 1pc magnetic converter.
- 5pc precision bits:
 - 3pc phillips: PH000, PH00, PH0
 - 2pc slotted: 1.5, 2.0mm



YJPS-6669

6pcs Precision Screwdriver Set



FEATURES:

- Ideal for repairing mobile phone, glasses, camera, computer etc.
- Ergonomic bit driver for better grip.
- Bits of chrome vanadium steel.

CONTAINS:

- 1pc aluminum screwdriver handle
- 5pc precision bits:
 - 1pc five pointed star bit: 0.8mm
 - 1pc phillips: PH000
 - 1pc slotted: 2.0mm
 - 2pc torx: T5, T6

YJPS-6165

Pocket Multi-purpose Tool

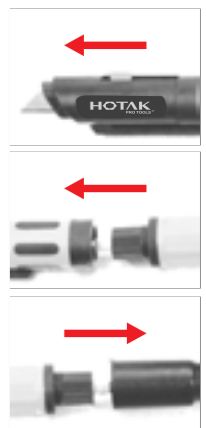

FEATURES:

- Compact pen screwdriver with 2 double ended bits made from top quality CR-V.
- Total of 2 screwdriver bits slotted SL2 & phillips PH1 Cr-V bits.
- Carefully grab and pull blade straight out.
- Non-slip molded grip.
- Convenient pocket clip.

ITEM	Packaging	Box/carton	Gw/Nw(kg)	MEAS(cm)
YJPS-6165D	Double blister	10/60	4.5/3.5	38*25*35



YJPS-6646

6pcs Quick Change Screwdriver Set



FEATURES:

- Ergonomic grip heavy duty handle for greater control, comfort and torque.
- Magnetic quick change adaptor.
- Rotary rear cap, bits can be stored inside handle.

CONTAINS:

- 1pc quick change screwdriver handle
- 5pc 75mm 1/4in. CR-V Bits:
 - 2pc slotted: 4.0, 5.0mm
 - 3pc phillips: PH0, PH1, PH2



YJPS-6645

8pcs Quick Change Screwdriver Set



FEATURES:

- Ergonomic grip heavy duty handle for greater control, comfort and torque.
- Magnetic quick change adaptor.
- Rotary rear cap, bits can be stored inside handle.

CONTAINS:

- 1pc quick change screwdriver handle
- 1pc 50mm 1/4in. extension shaft
- 6pc 25mm 1/4in. CR-V bits:
 - 2pc slotted: 4.0, 5.0mm
 - 2pc phillips: PH1, PH2
 - 2pc torx: T15, T20



YJPS-6155

6 in1 Ratchet Screwdriver Set



FEATURES:

- Ergonomic handle with non-slip TPR grip.
- Bits storage function in handle.
- High torque 3-position ratchet.
- Chrome Vanadium steel bits.
- Adjustable handle allows Ratchet to swing max 60° to each side.

CONTAINS:

- 3pc phillips bits: PH1, PH2, PH3
- 3pc slotted bits: 4.0, 5.0, 6.0mm

ITEM	Packaging	Box/carton	Gw/Nw(kg)	MEAS(cm)
YJPS-6155D	Double blister	6/36	7.7/6.7	39.3*28*37.5

YJPS-6191

26pcs Ratchet Screwdriver Set



FEATURES:

- Ergonomic handle with non-slip TPR grip.
- Bits storage function in handle.
- High torque 3-position ratchet.
- Chrome Vanadium steel bits.
- Adjustable handle allows Ratchet to swing max 60° to each side.

CONTAINS:

- 6pc phillips bits: PH0, PH1, PH1, PH2, PH2, PH3
- 6pc slotted bits: 2.5, 3.0, 4.0, 5.0, 5.5, 6.0mm
- 6pc torx bits: T15, T20, T25, T27, T30, T40
- 5pc hex bits: 3.0, 4.0, 5.0, 5.5, 6.0mm
- 1pc socket adapter
- 1pc ratchet screwdriver
- 1pc 50mm 1/4 in. zinc alloy and black finish CR-V 6150 adaptor

ITEM	Packaging	Box/carton	Gw/Nw(kg)	MEAS(cm)
YJPS-6191D	Double blister	6/24	9.5/8.5	32.5*29.5*35.5

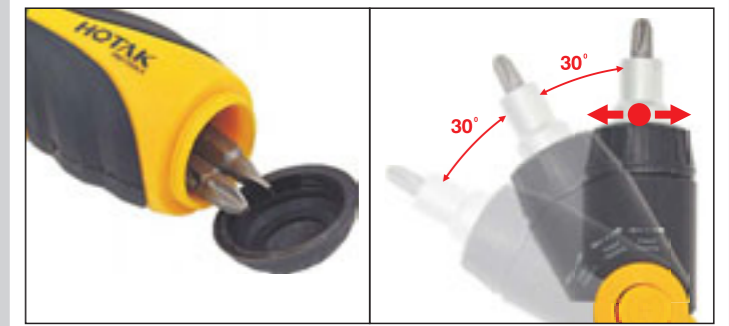

YJPS-6192

24pcs Ratchet Screwdriver Set



FEATURES:

- Ergonomic handle with non-slip TPR grip.
- Bits storage function in handle.
- High torque 3-position ratchet.
- Chrome Vanadium steel bits.
- Adjustable handle allows Ratchet to swing max 60° to each side.

CONTAINS:

- 4pc phillips bits: PH0, PH1, PH2, PH3
- 4pc slotted bits: 3.0, 4.0, 5.0, 6.0mm
- 3pc hex bits: 5.0, 5.5, 6.0mm
- 10pc sockets: 4, 5, 6, 7, 8, 9, 10, 11, 12, 13mm
- 1pc socket adapter
- 1pc ratchet screwdriver
- 1pc 50mm 1/4 in. zinc alloy and black finish CR-V 6150 adaptor

ITEM	Packaging	Box/carton	Gw/Nw(kg)	MEAS(cm)
YJPS-6192D	Double blister	6/24	10.7/9.7	32.5*29.5*35.5



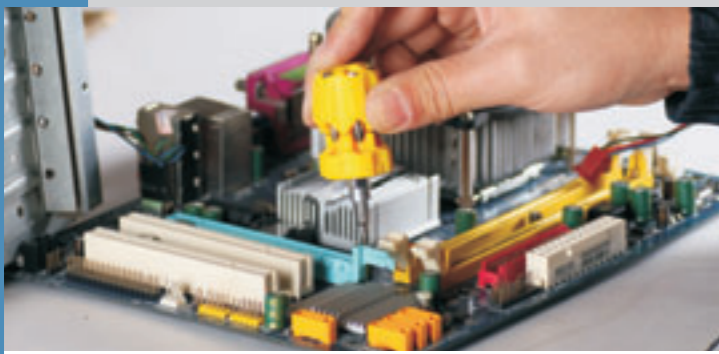

YJPS-6501

6 IN 1 Stubby Screwdriver



FEATURES:

- Delicate appearance and measure is convenient to be carried and used .
- Cr-V Metallic tools with forged arm.
- Batteries included.
- Chrome vanadium steel for maximum performance.

ITEM	Packaging	Box/carton	Gw/Nw(kg)	MEAS(cm)
YJPS-6501D	Double blister	12/48	7.4/6.4	39*40*23.5

YJPS-6503

7 IN 1 Precision Srewdriver Set



FEATURES:

- Ergonomic handle with extension bar can go to hard reach area.
- Multiple size for all applications.
- Chrome vanadium steel bits.

CONTAINS:

- 1pc aluminium handle
- 7pc bits:
 - 1pc star: 0.8mm
 - 2pc phillip: PH000, PH00
 - 4pc torx: T4, T5, T6

ITEM	Packaging	Box/carton	Gw/Nw(kg)	MEAS(cm)
YJPS-6503D	Double blister	12/48	5/4	43.5*20.7*29.5

YJPS-6502

Aluminum Ratchet Handle



FEATURES:

- Delicate appearance and dimension is convenient to be carried and used.
- Ergonomic aluminum handle providing maximum speed and torque.
- Easy Operation.

CONTAINS:

- 1pc aluminium ratchet handle
- 1pc phillips: PH1
- 1pc slotted: 5mm

ITEM	Packaging	Box/carton	Gw/Nw(kg)	MEAS(cm)
YJPS-6502D	Double blister	8/48	4.5/3.5	40.5*36*19.8

YJPS-6504

7 IN 1 Adaptor



FEATURES:

- For heating, air-conditioning, sanitary and building engineering.
- With bit insert: slotted 5 mm and Phillips #2.
- With adapter for 1/4-Bits on securing chain and an additional adapter for 1/4-Bits.
- Zinc die-casting.

ITEM	Packaging	Box/carton	Gw/Nw(kg)	MEAS(cm)
YJPS-6504D	Double blister	12/48	5/4	43.5*20.7*29.5



YJPS-352

6pcs Precision Screwdriver Set



FEATURES:

- Box for easy storage and convenient carrying.
- Ergonomical handle provides firm and comfortable grips.
- Specification mark is easy to read.

CONTAINS:

- 2pc phillips: PH0, PH1
- 4pc slotted: 1.4, 2, 2.4, 3mm

ITEM	Packaging	Box/carton	Gw/Nw(kg)	MEAS(cm)
YJPS-352D	Double blister	10/60	10.6/9.6	46.5*29*42

YJPS-6352

14pcs Precision Screwdriver Set



FEATURES:

- Chrome Vanadium Steel (CR-V)bits have a solid base, providing a significant advantage in rigidity and function when compared to conventional bits.
- Easy operation.
- High quality plastic handle.
- Convenient for use in small places or corners.

CONTAINS:

- 1pc screwdriver handle
- 13pc precision bits 28mm:
 - 3pc phillips: PH00, PH0, PH1
 - 3pc PZ: PZ0, PZ1, PZ2
 - 2pc torx: T10, T15
 - 2pc slotted: 2.0, 2.5mm
 - 3pc speciality bits:
 - tri-wing:3.0mm
 - triangle:3.0mm
 - spanner: 2.6mm

ITEM	Packaging	Box/carton	Gw/Nw(kg)	MEAS(cm)
YJPS-352D	Double blister	6/48	5/4	49*26*27.5

YJPS-353

6pcs Precision Screwdriver Set



FEATURES:

- Easy storage and convenient carrying
- CR-V blades with black finish promise long-time rust resistance.

CONTAINS:

- 2pc phillips: PH0, PH1
- 4pc slotted: 1.4, 2, 2.4, 3mm

YJPS-6262

4pcs Aluminium Precision Screwdriver Set



FEATURES:

- Ergonomic non-slip grip
- Aluminum handle with rotate cap.
- High grade hardened alloy CR-V blades for great torque.
- Accurate processed tips provide precise operation.

CONTAINS:

- 2pc phillips: PH0, PH1
- 2pc slotted: 2.0, .3.0mm

ITEM	Packaging	Box/carton	Gw/Nw(kg)	MEAS(cm)
YJPS-6262D	Double blister	6/48	5.5/4.5	26*24.5*22.5



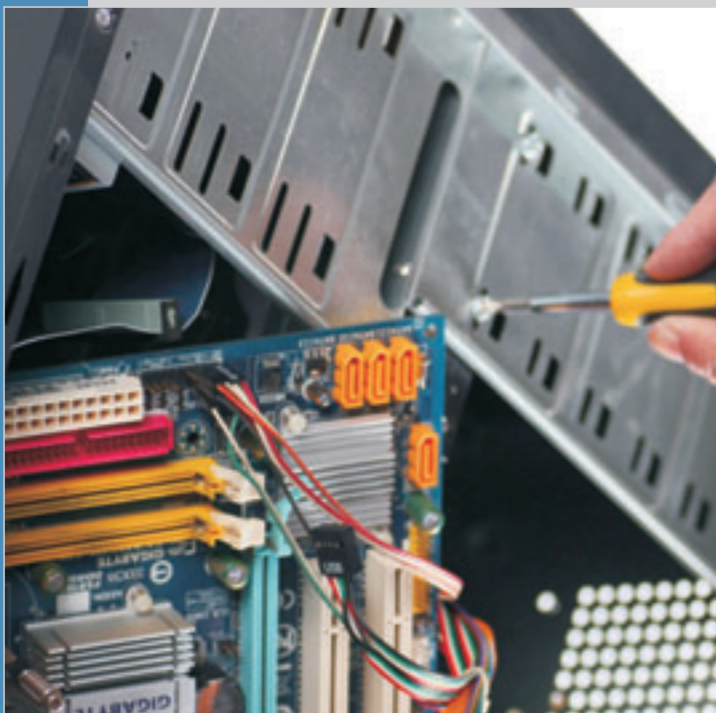

YJPS-6280

31pcs Screwdriver Bits Set



FEATURES:

- CR-V precision screwdriver bits.
- Precision design for small repair, computers, jewelry and more...
- Designed to get into hard-reach areas.

CONTAINS:

- 1pc bit driver
- 1pc flexible extension bar
- 1pc magnifier
- 28pc CR-V bits
 - 5pc phillips: PH000, PH00, PH0, PH1, PH2
 - 7pc slotted: 1.2, 1.5, 2.0, 2.5, 3.0, 3.5, 4.0mm
 - 7pc torx: T5, T6, T7, T8, T10, T15, T20
 - 7pc hex: 0.9, 1.0, 1.3, 2.0, 2.5, 3.0, 4.0mm
 - 1pc triangle: 3.0mm
 - 1pc tri-wing: 3.0mm

ITEM	Packaging	Box/carton	Gw/Nw(kg)	MEAS(cm)
YJPS-6280D	Double blister	6/24	5.4/4.4	27.3*26*27.5



YJPS-6281

37pcs Screwdriver Bits Set



FEATURES:

- CR-V precision screwdriver bits.
- Precision design for small repair, computers, jewelry and more...
- Designed to get into hard-reach areas.

CONTAINS:

- 1pc ratchet bit driver
- 1pc flexible extension bar
- 7pc mini socket
- 28pc CR-V bits
 - 5pc phillips: PH000, PH00, PH0, PH1, PH2
 - 7pc slotted: 1.2, 1.5, 2.0, 2.5, 3.0, 3.5, 4.0mm
 - 7pc torx: T5, T6, T7, T8, T10, T15, T20
 - 7pc hex: 0.9, 1.0, 1.3, 2.0, 2.5, 3.0, 4.0mm
 - 1pc triangle: 3.0mm
 - 1pc tri wing: 3.0mm

ITEM	Packaging	Box/carton	Gw/Nw(kg)	MEAS(cm)
YJPS-6280D	Double blister	6/24	5.5/4.5	27.3*26*27.5

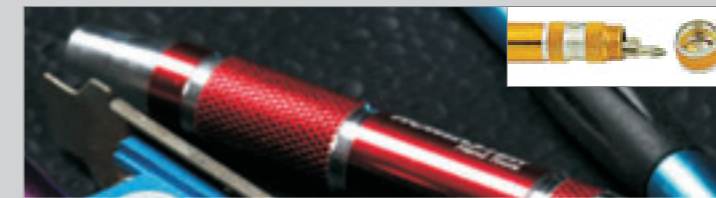
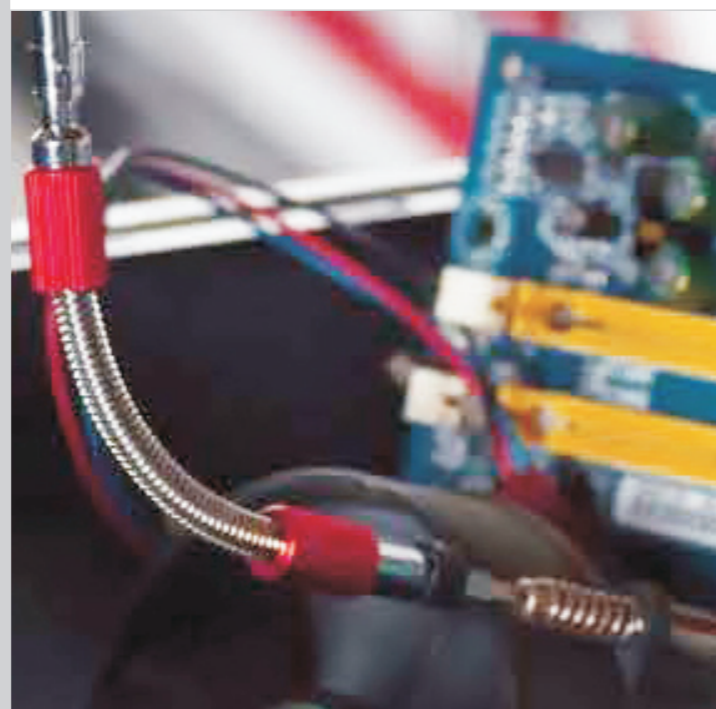

YJPS-386

9in1 Screwdriver Bit Set



FEATURES:

- Ergonomical handle provides firm and comfortable grip.
- Features handy pen style bit holder.
- CR-V precision screwdriver blade.
- Surface: nickel finish.

CONTAINS:

- 1pc slim aluminium bit holder (screwdriver handle).
- 3pc phillips: PH00, PH0, PH1.
- 3pc slotted: 1.0, 1.5, 2.0mm.
- 3pc torx: T6, T7, T8.

ITEM	Packaging	Box/carton	Gw/Nw(kg)	MEAS(cm)
YJPS-386D	Double blister	12/72	5.4/4.4	57*21.5*26.5

YJPS-767

18pcs Aluminium Screwdriver Holder and Bit Set



FEATURES:

- Ergonomical handle provides firm and comfortable grip.
- Features handy pen style bit holder.
- CR-V precision screwdriver blade.
- Surface: nickel finish.

CONTAINS:

- 2pc anodized aluminum bit holders.
- 16pc CR-V bits
 - 4pc slotted: 1.5, 2, 2.5, 3mm or (1/32", 3/64", 5/64", 3/32")
 - 4pc phillips: #000, #00, #0, #1;
 - 4pc star: T4, T5, T6, T7;
 - 4pc hex: 0.7, 0.9, 1.3, 1.5mm.

ITEM	Packaging	Box/carton	Gw/Nw(kg)	MEAS(cm)
YJPS-767D	Double blister	6/48	6.6/5.6	46.5*29.5*27.5

YJPS-788

15pcs Aluminium Screwdriver Holder and Bit Set



FEATURES:

- Ergonomical handle provides firm and comfortable grip.
- Features handy pen style bit holder.
- CR-V precision screwdriver blade.
- Surface: nickel finish.

CONTAINS:

- 3pc anodized aluminum bit holders.
- 12pc CR-V bits
 - 4pc slotted: 1.5, 2, 2.5, 3mm or (1/32", 3/64", 5/64", 3/32";)
 - 4pc phillips: #000, #00, #0, #1;
 - 4pc hex: 1.5, 2, 2.5, 3mm.

ITEM	Packaging	Box/carton	Gw/Nw(kg)	MEAS(cm)
YJPS-788D	Double blister	10/40	6.4/5.4	36*31*29.5

YJPS-765

20pcs Aluminium Screwdriver Holder and Bit Set



FEATURES:

- Ergonomical handle provides firm and comfortable grip.
- Features handy pen style bit holder.
- CR-V precision screwdriver blade.
- Surface: nickel finish.

CONTAINS:

- 4pc anodized aluminum bit holders.
- 16pc CR-V bits
 - 4pc slotted: 1.5, 2, 2.5, 3mm (1/32", 3/64", 5/64", 3/32");
 - 4pc phillips: #000, #00, #0, #1;
 - 4pc star: T4, T5, T6, T7;
 - 4pc hex: 0.7, 0.9, 1.3, 1.5mm.

ITEM	Packaging	Box/carton	Gw/Nw(kg)	MEAS(cm)
YJPS-765D	Double blister	6/48	9/8	47.5*39.5*28.5

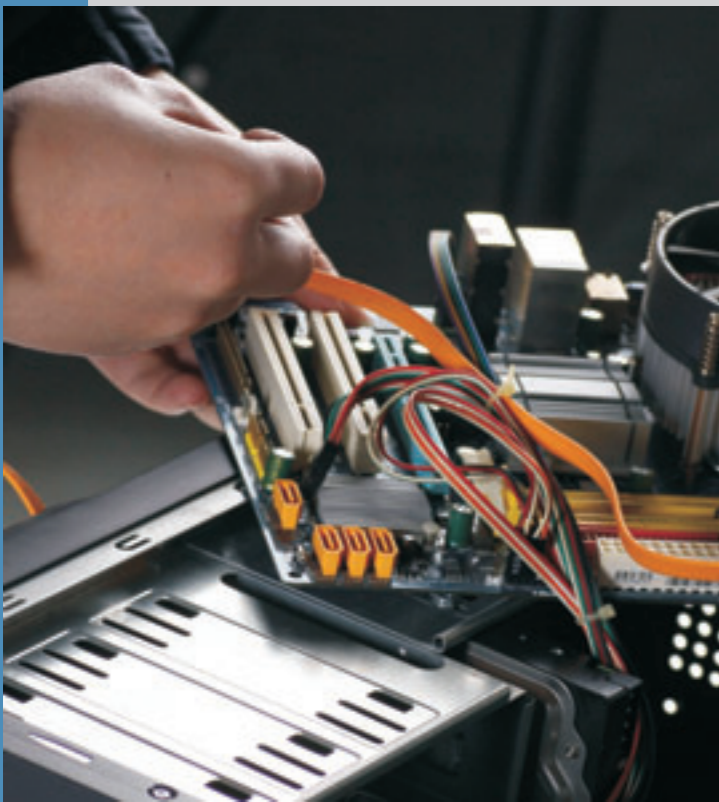

YJPS-6034

14pcs Precision Screwdriver Set with tweezers



FEATURES:

- CR-V blades, dual- color handle.
- Non-slip sleeves for greser grip and control.
- Blades made of Chrome Vanadium Steel ensure greater hardness, strength and durability.
- Satin chrome plated resists rust and corrosion.
- Ideal for TV repair, instrumentation, cameras, Computers, vcrs, telephones etc.

CONTAINS:

- 1pc offset tweezers
- 1pc straight tweezers
- 6pc screwdrivers with 40mm long blades:
Phillips: PH00, PH0, PH1
Slotted: 1.4, 1.8, 2.4mm
- 6pc screwdrivers with 75mm long blades:
Phillips: 2xPH00, 2xPH0, 2xPH1

ITEM	Packaging	Box/carton	Gw/Nw(kg)	MEAS(cm)
YJPS-6034B	Bulk	6/24	10.2/9.2	34.3*32*32.5

YJPS-6035

6pcs Precision Screwdriver Set



FEATURES:

- CR-V blades, dual- color handle.
- Non-slip sleeves for greser grip and control.
- Blades made of Chrome Vanadium Steel ensure greater hardness, strength and durability.
- Satin chrome plated resists rust and corrosion.
- Ideal for TV repair, instrumentation, cameras, Computers, vcrs, telephones etc.

CONTAINS:

- 2pc precision screwdrivers, blade length:
45mm-PH00, slotted-2mm
- 2pc precision screwdrivers, blade length:
75mm-PH0, slotted-3mm
- 2pc precision screwdrivers, blade length:
100mm-PH1, slotted-4mm

ITEM	Packaging	Box/carton	Gw/Nw(kg)	MEAS(cm)
YJPS-6035D	Double Blister	10/60	10.8/9.8	43*28.5*31.5

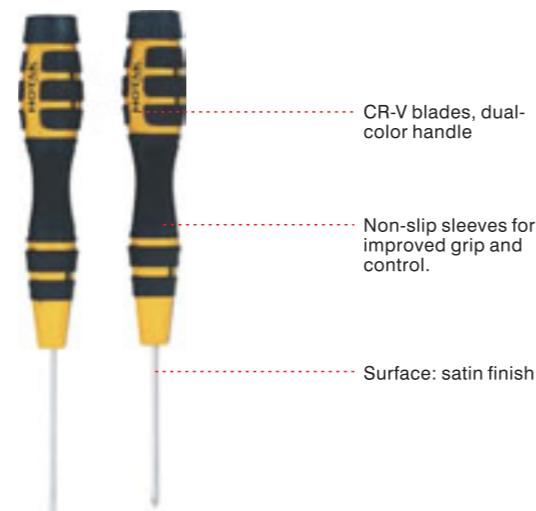

YJPS-6028

13pcs Precision Screwdriver & Bits Set



FEATURES:

- Aluminum screwdriver handle with TPR grip.
- Ergonomic shaft for better grip.
- CR-V precision screwdriver blade.
- Surface: satin finish.

CONTAINS:

- 1pc aluminium handle with 6pcs bits:
Torx: T5, T6, T7
Hex key: 0.5, 1.0, 2.5mm;
- 6pc aluminum precision screwdriver with TPR grip:
Slotted: 2.4, 2.0mm
Phillips: PH0, PH1
Torx: T8, T9

ITEM	Packaging	Box/carton	Gw/Nw(kg)	MEAS(cm)
YJPS-6028D	Double Blister	12/48	10/9	51.5*25.5*29.5

YJPS-6029

7pcs Precision Screwdriver & Magnifier Set



FEATURES:

- Aluminum screwdriver handle with TPR grip.
- Ergonomic shaft for better grip.
- CR-V precision screwdriver blade.
- Surface: satin finish.

CONTAINS:

- 1pc magnifier
- 2pc slotted bits: 2.0, 3.0mm
- 2pc phillips bits: PH0, PH1
- 2pc torx bits: T9, T10

ITEM	Packaging	Box/carton	Gw/Nw(kg)	MEAS(cm)
YJPS-6029D	Double Blister	12/48	9.8/8.8	50.5*26.5*27.5



YJPS-6030

13pcs Precision Screwdriver & Bits Set



FEATURES:

- Aluminum screwdriver handle with TPR grip.
- Ergonomic shaft for better grip.
- CR-V precision screwdriver blade.
- Surface: satin finish.

CONTAINS:

- 3pc slotted bits: 2.0, 2.5, 3.0mm
- 3pc phillips bits: PH00, PH0, PH1
- 7pc folding hex key: 1.5, 2.0, 2.5, 3.0, 4.0, 5.0, 6.0mm

ITEM	Packaging	Box/carton	Gw/Nw(kg)	MEAS(cm)
YJPS-6030D	Double Blister	6/24	7.2/6.2	28.5*26*38.5



YJPS-6913

11pcs Precision Screwdriver & Bits Set

Open Automatically



FEATURES:

- Two-ribbon switch storage box.
- Convenient storage and carrying.
- Surface: nickel finish.

CONTAINS:

- 1pc ratchet handle
- 2pc phillips: PH1, PH2
- 2pc slotted: 4, 5mm
- 2pc pozi: PZ1, PZ2
- 2pc hex: 4.0, 5.0mm
- 2pc torx: T15, T20

ITEM	Packaging	Box/carton	Gw/Nw(kg)	MEAS(cm)
YJPS-6913D	Double Blister	6/36	11.3/10.3	43*46.2*43.5



YJPS-773

16pcs Precision Screwdriver & Bits Set

Open Automatically



FEATURES:

- Two-ribbon switch storage box.
- Convenient storage and carrying.
- Surface: nickel finish.

CONTAINS:

- 1pc 110mm extension bar
- 1pc dual-color precision screwdriver handle
- 14pc CR-V bits size:
 - 4pc phillips: PH000, PH00, PH0, PH1
 - 5pc torx: T5, T6, T7, T8, T9
 - 5pc slotted: 1.5, 2.0, 2.5, 3.0, 4mm

ITEM	Packaging	Box/carton	Gw/Nw(kg)	MEAS(cm)
YJPS-773D	Double Blister	6/36	8.9/7.9	43*46.2*43.5

YJPS-6912

19pcs Precision Screwdriver & Bits Set

Open Automatically



FEATURES:

- Two-ribbon switch storage box.
- Convenient storage and carrying.
- Surface: nickel finish.

CONTAINS:

- 7pcs sockets: 5, 6, 7, 8, 9, 10, 12mm
- 2pcs phillips: PH1, PH2
- 1pc extension bar
- 1pc ratchet handle
- 2pc slotted: 4, 5mm
- 2pc pozi: PZ1, PZ2
- 2pc hex: 4.0, 5.0mm
- 2pc torx: T15, T20

ITEM	Packaging	Box/carton	Gw/Nw(kg)	MEAS(cm)
YJPS-6912D	Double Blister	6/36	13.8/12.8	43*46.2*43.5

YJPS-797

6pcs Precision Screwdriver Set



FEATURES:

- CR-V blades, dual color handle.
- Non-slip sleeves for better grip and control.
- Blades made of Chrome Vanadium Steel ensure greater hardness, strength and durability.
- Satin chrome plated resists rust and corrosion.
- Ideal for TV repair, instrumentation, cameras, computers, vcrcs, telephones etc.

CONTAINS:

- 3pc slotted: 2.0, 3.0, 4.0mm.
- 3pc phillips: PH1, PH0, PH00.

ITEM	Packaging	Box/carton	Gw/Nw(kg)	MEAS(cm)
YJPS-797D	Double Blister	6/48	10.6/9.6	56*43*30.5

YJPS-798

10pcs Precision Screwdriver Set



FEATURES:

- CR-V blades, dual color handle.
- Non-slip sleeves for better grip and control.
- Blades made of Chrome Vanadium Steel ensure greater hardness, strength and durability.
- Satin chrome plated resists rust and corrosion.
- Ideal for TV repair, instrumentation, cameras, computers, vcrcs, telephones etc.

CONTAINS:

- 3pc slotted: 2.0, 3.0, 4.0mm.
- 3pc phillips: PH00, PH0, PH1.
- 4pc torx: T7, T8, T9, T10.

ITEM	Packaging	Box/carton	Gw/Nw(kg)	MEAS(cm)
YJPS-798D	Double Blister	6/24	8/7	41.5*34*35.5

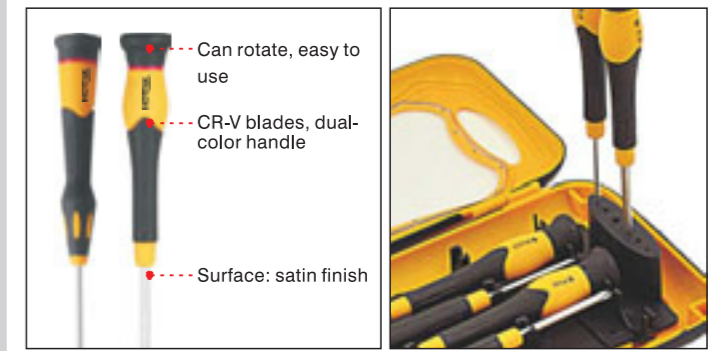

- Can rotate, easy to use
- CR-V blades, dual-color handle
- Surface: satin finish

YJPS-756

6pcs Precision Screwdriver Set



FEATURES:

- CR-V blades, dual color handle.
- Non-slip sleeves for better grip and control.
- Blades made of Chrome Vanadium Steel ensure greater hardness, strength and durability.
- Satin chrome plated resists rust and corrosion.
- Ideal for TV repair, instrumentation, cameras, computers, vcrcs, telephones etc.

CONTAINS:

- 3pc slotted: 2.0, 3.0, 4.0mm.
- 3pc phillips: PH1, PH0, PH00.

ITEM	Packaging	Box/carton	Gw/Nw(kg)	MEAS(cm)
YJPS-756D	Double Blister	5/20	10/9	36.5*34*53.5

YJPS-757

6pcs Precision Screwdriver Set



FEATURES:

- CR-V blades, dual color handle.
- Non-slip sleeves for better grip and control.
- Blades made of Chrome Vanadium Steel ensure greater hardness, strength and durability.
- Satin chrome plated resists rust and corrosion.
- Ideal for TV repair, instrumentation, cameras, computers, vcrcs, telephones etc.

CONTAINS:

- 3pc slotted: 2.0, 3.0, 4.0mm.
- 3pc phillips: PH1, PH0, PH00.

ITEM	Packaging	Box/carton	Gw/Nw(kg)	MEAS(cm)
YJPS-757D	Double Blister	5/20	10/9	36.5*34*53.5



YJPS-384

31pcs Precision Screwdriver Set



FEATURES:

- CR-V precision screwdriver bits.
- Ergonomic handle with soft grip for increased torque delivery and comfort in use.
- Precision formatted bits for better engaging fasteners.
- Surface: nickel finish.

CONTAINS:

- 1pc screwdriver handle (bits holder)
- 4pc phillips bits: PH00, PH0, PH1, PH2
- 6pc slotted bits: 1.5, 2.0, 2.5, 3.0, 3.5, 4.0mm
- 8pc torx bits: T4, T5, T6, T7, T8, T10, T15, T20,
- 7pc hex bits: 1.0, 1.3, 1.5, 2.0, 2.5, 3.0, 4.0mm
- 5pc special bits: Triangle-3mm, Tri wing-3mm
Five pointed star bit-2mm
Spanner-bit 2.6mm, Round bit-1mm

ITEM	Packaging	Box/carton	Gw/Nw(kg)	MEAS(cm)
YJPS-384D	Double Blister	6/24	5.4/4.4	53.5*27*22.5

YJPS-383

32pcs Precision Screwdriver With Extension Bar



FEATURES:

- Designed to get into hard-reach areas.
- Bits made of chrome vanadium steel ensures greater hardness, strength and durability.
- Surface: nickel finish.
- Ergonomic handle with soft grip for increased, torque delivery and confort in use.

CONTAINS:

- 1pc screwdriver handle (bits holder)
- 1pc extension bar
- 4pc phillips bits: PH00, PH0, PH1, PH2,
- 6pc slotted bits: 1.5, 2.0, 2.5, 3.0, 3.5, 4.0mm
- 8pc torx bits: T4, T5, T6, T7, T8, T10, T15, T20
- 7pc hex bits: 1.0, 1.3, 1.5, 2.0, 2.5, 3.0, 4.0mm
- 5pc special bits: Triangle-3mm, Tri wing-3mm
Five pointed star bit-2mm
Spanner-bit 2.6mm, Round bit 1mm

ITEM	Packaging	Box/carton	Gw/Nw(kg)	MEAS(cm)
YJPS-383D	Double Blister	6/24	7.4/6.4	35.5*32.5*33.5

YJPS-382

20pcs Precision Screwdriver Set



FEATURES:

- Bits made of chrome vanadium steel ensures greater hardness, strength and durability.
- Surface: nickel finish.
- Ergonomic handle with soft grip for increased, torque delivery and confort in use.

CONTAINS:

- 4pc phillips: PH000, PH00, PH0, Ph1
- 5pc slotted: 1.5, 2.0, 2.5, 3.0, 4.0mm
- 5pc torx external: T5, T6, T7, T9, T15
- 3pc torx Internal: T8, T10, T15
- 1pc spanner slotted: 2.6mm
- 1pc triangle: 3.0
- 1pc tri wing: 3.0mm

ITEM	Packaging	Box/carton	Gw/Nw(kg)	MEAS(cm)
YJPS-382D	Double Blister	10/40	9/8	51*27*38.5

YJPS-760

6pcs Precision Screwdriver Set



FEATURES:

- Blade made of Chrome Vanadium Steel ensures greater, hardness, strength and durability.
- Satin chrome plated resists rust and corrosion.
- Spinning end caps for quick operation.
- Ergonomical handle provides firm and comfortable grips.
- Ideal for TV repair, instrumentation, cameras, computers, vcrcs, telephones etc.

CONTAINS:

- 3pc slotted: 1.4, 1.8, 2.4mm
- 3pc phillips: PH00, PH0, PH1

ITEM	Packaging	Box/carton	Gw/Nw(kg)	MEAS(cm)
YJPS-760D	Double Blister	6/36	8.5/7.5	49.5*25.5*39.5

YJPS-6040

10pcs Precision Screwdriver Set



FEATURES:

- Blade made of Chrome Vanadium Steel ensures greater, hardness, strength and durability.
- Satin chrome plated resists rust and corrosion.
- Spinning end caps for quick operation.
- Ergonomical handle provides firm and comfortable grips.
- Ideal for TV repair, instrumentation, cameras, computers, vcrcs, telephones etc.

CONTAINS:

- 3pc slotted: 1.4, 1.8, 2.4mm
- 3pc phillips: PH00, PH0, PH1
- 4pc torx: T7, T8, T9, T10.

ITEM	Packaging	Box/carton	Gw/Nw(kg)	MEAS(cm)
YJPS-6040D	Double Blister	6/36	15/14	57.5*51.5*24.5

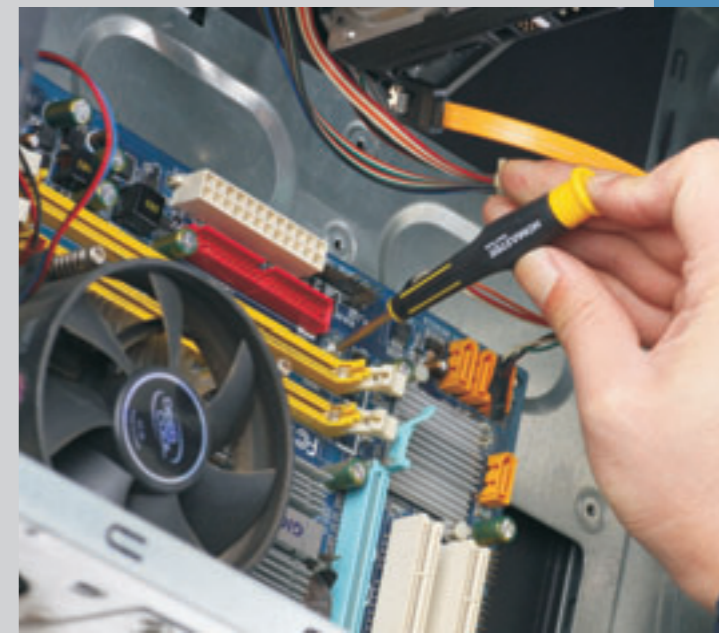

YJPS-761

15pcs Precision Screwdriver Set



FEATURES:

- Blade made of Chrome Vanadium Steel ensures greater, hardness, strength and durability.
- Satin chrome plated resists rust and corrosion.
- Spinning end caps for quick operation.
- Ergonomical handle provides firm and comfortable grips.
- Ideal for TV repair, instrumentation, cameras, computers, vcrcs, telephones etc.

CONTAINS:

- 3pc phillips: PH00, PH0, PH1,
- 3pc slotted: 1.4, 1.8, 2.4 mm,
- 3pc hex: 1.5, 2, 2.5mm,
- 6pc torx: T5, T6, T7, T8, T9, T10

ITEM	Packaging	Box/carton	Gw/Nw(kg)	MEAS(cm)
YJPS-761D	Double Blister	6/24	10.6/9.6	36.5*31.5*46.5



YJPS-762

9pcs Precision Tool Set



FEATURES:

- Blade made of Chrome Vanadium Steel ensures greater, hardness, strength and durability.
- Satin chrome plated resists rust and corrosion.
- Spinning end caps for quick operation.
- Ergonomical handle provides firm and comfortable grips.
- Ideal for TV repair, instrumentation, cameras, computers, vcrs, telephones etc.

CONTAINS:

- 3pc phillips: PH00, PH0, PH1
- 3pc slotted: 1.4, 1.8, 2.4mm
- 1pc mini diagonal plier
- 1pc mini long nose plier
- 1pc magnifying glasses

ITEM	Packaging	Box/carton	Gw/Nw(kg)	MEAS(cm)
YJPS-762D	Double Blister	6/24	11.4/10.4	57.5*41*24.5

YJPS-389

12 In 1 Ratchet Screwdriver And Bits Set



FEATURES:

- Bits with phosphating treatment.
- Ergonomic shaft for better grip.
- Absolute precision, highest consistency.

CONTAINS:

- 2pc slotted: 4.5, 5.5mm
- 2pc phillips: PH1, PH2
- 2pc pozi: PZ1, PZ2
- 6pc torx: T10, T15, T20, T25, T30, T40
- 1pc 1/4" ratchet bits handle.

ITEM	Packaging	Box/carton	Gw/Nw(kg)	MEAS(cm)
YJPS-389D	Double Blister	10/40	13/12	50.5*29*44.5



YJPS-380

32pcs Magnetic Driver Guide Kit With Self-Standing Case



FEATURES:

- CR-V bits with phosphating treatment.
- Magnetic bit tip holder included.

CONTAINS:

- 1pc extension bar
- 9pc phillips bits: PH1, 7xPH2, PH3
- 7pc slotted bits: S6, 5xS8, S10
- 6pc square bits: SL1, 4xSL2, SL3
- 4pc hex bits: 2x5/32", 3/16", 1/4"
- 4pc torx bits: T10, 2xT15, T20
- 1pc magnetic driver guide all bits in a self-standing case

ITEM	Packaging	Box/carton	Gw/Nw(kg)	MEAS(cm)
YJPS-380D	Double Blister	10/40	16/15	37.5*34*33

YJPS-6590

15pcs Precision Ratchet Screwdriver Set



FEATURES:

- Ergonomic handle with non-slip TPR grip.
- Multiple sizes for all applications.
- High torque ratchet.

CONTAINS:

- 1pc aluminium handle
- 7pc torx bits: T5, T6, T7, T8, T10, T15, T20
- 7pc hex bits: 0.9, 1.0, 1.3, 2.0, 2.5, 3.0, 4.0



YJPS-350

6pcs Precision Screwdriver Set



FEATURES:

- Chrome plated handle promise long-time rust resistance.
- CR-V blades with black finish.

CONTAINS:

- 2pc phillips: PH0, PH1
- 4pc slotted: 1.0, 1.4, 2.0, 2.4mm

ITEM	Packaging	Box/carton	Gw/Nw(kg)	MEAS(cm)
YJPS-350D	Double Blister	10/60	11.6/10.6	48.5*48.5*29

YJPS-351

6pcs Precision Screwdriver Set



FEATURES:

- Chrome plated handle promise long-time rust resistance.
- CR-V blades with black finish.

CONTAINS:

- 2pc phillips: PH0, PH1
- 4pc slotted: 1.4, 2, 2.4, 3mm

ITEM	Packaging	Box/carton	Gw/Nw(kg)	MEAS(cm)
YJPS-351D	Double Blister	10/60	13.2/12.2	48.5*48.5*29

YJPS-362

6pcs Precision Screwdriver Set



FEATURES:

- Chrome plated handle promise long-time rust resistance.
- CR-V blades with black finish.

CONTAINS:

- 2pc phillips: PH0, PH1
- 4pc slotted: 1.4, 2, 2.4, 3mm

ITEM	Packaging	Box/carton	Gw/Nw(kg)	MEAS(cm)
YJPS-362D	Double Blister	12/120	10/9	35*30.5*34.5

YJPS-2037

6pc Aluminum Precision Screwdriver Set

-
-



FEATURES:

- Ergonomic shape provides a pleasant grip, excellent tightening torque for wet or oily work environments.
- CR-V blade.
- Colorful aluminum handle.
- Swivel top handle for easy turning around.

CONTAINS:

- 3pc slotted: 2.0, 2.4, 3.0mm
- 3pc phillips: PH00, PH0, PH1

ITEM	Packaging	Box/carton	Gw/Nw(kg)	MEAS(cm)
YJPS-2037B	PP case	10/40	8.2/7.5	39.5*23*29.5



YJPS-6110

16pcs Precision Screwdriver & Bits Set



FEATURES:

- Professional grade tools.
- Ergonomic shaft for better grip.
- CR-V precision bits.

CONTAINS:

- 1pc aluminum screwdriver handle
- 2pc phillips: PH0, PH1
- 4pc slotted: SL1.5, SL2, SL2.5, SL3
- 4pc hex: H1.5, H2.0, H2.5, H3.0
- 5pc torx: T6, T7, T8, T10, T15

ITEM	Packaging	Box/carton	Gw/Nw(kg)	MEAS(cm)
YJPS-6110D	Double Blister	6/36	6.6/5.6	43.5*26*41.5

YJPS-6150

13pcs Precision Screwdriver Set



FEATURES:

- CR-V blade with special heat treated.
- Aluminum alloy handle with replaceable blades.
- Dermic wallet design, convenient to carry, elegant appearance.
- This product only used for repairing of precision device such as electronic, eyeglass and horologe.

CONTAINS:

- 3pc phillips: PH000, PH00, PH0
- 3pc slotted: SL1.5, SL2.0, SL2.5
- 6pc torx: T5, T6, T7, T8, T9, T10
- 1pc aluminum alloy handle

ITEM	Packaging	Box/carton	Gw/Nw(kg)	MEAS(cm)
YJPS-6150D	Double Blister	12/48	8.8/7.8	42*38*29



YJTS-2013

21pcs Auto-use Repair Set



FEATURES:

- Only one set for all applications: easier to use- safe to work with.
- T type screwdriver bits and socket handle, no stress between fingers at use.
- Hard PP core with soft and easy-to-grip TPR casing allows higher torques, even if handled with wet or moist hands.

CONTAINS:

- 1pc T type screwdriver bits and socket handle
- 9pc socket: 5, 6, 7, 8, 9, 10, 11, 12, 13mm
- 10pc screwdriver bits
 - 2pc phillips: PH1, PH2
 - 2pc torx: T15, T20
 - 2pc slotted: 4.0, 5.0mm
 - 2pc pozi: PZ1, PZ2
 - 2pc hex: 4.0, 5.0mm

ITEM	Packaging	Box/carton	Gw/Nw(kg)	MEAS(cm)
YJTS-2013D	Double Blister	6/24	12/11	43.5*33.5*31.5

YJPS-6650

12pcs Magnetic Diver Guide Set



FEATURES:

- A simple and practical small portfolio.

CONTAINS:

- 2pc Phillips bits: PH2, PH3
- 3pc Slotted bits: #6, #8, #10
- 2pc square bits: #1, #2
- 2pc hex bits: 5/32", 3/16"
- 1pc Torx: T15
- 2pc magnetic bit tip handle

YJPS-381

11pcs Magnetic Driver Guide Kit with self-standing case



FEATURES:

- CR-V bits with phosphating treatment.
- Magnetic Bit Tip Holder Included.

CONTAINS:

- 2pc phillips bits: PH2, PH3
- 3pc slotted bits: #6, #8, #10
- 2pc square bits: #1, #2,
- 2pc hex bits: 5/32", 3/16"
- 1pc torx: T15
- 1pc magnetic driver guide all bits in a self-standing case

ITEM	Packaging	Box/carton	Gw/Nw(kg)	MEAS(cm)
YJPS-381D	Double Blister	10/40	8/7	29*27*40.5

YJPS-388

6 In 1 Quickadapter And Bits Set



FEATURES:

- Bits with phosphating treatment.
- Designed to get into hard-reach areas.
- Absolute precision, highest consistency.

CONTAINS:

- 3pc phillips: PH0, PH1, PH2
- 3pc torx: T10, T15, T20
- 1pc quick-release quick adapter and universal bit holder.

ITEM	Packaging	Box/carton	Gw/Nw(kg)	MEAS(cm)
YJPS-388D	Double Blister	12/48	6/5	40*23.5*29.5

YJPS-387

9 In 1 Quickadapter And Bits Set



FEATURES:

- Bits with phosphating treatment.
- Designed to get into hard-reach areas.
- Absolute precision, highest consistency.

CONTAINS:

- 3pc pozi: PZ1, PZ2, PZ3
- 6pc torx: T10, T15, T20, T25, T30, T40
- 1pc quick-release quick adapter and universal bit holder.

ITEM	Packaging	Box/carton	Gw/Nw(kg)	MEAS(cm)
YJPS-387D	Double Blister	6/24	4.2/3.2	30.5*24.5*21.5



YJPS-355

6pcs Electronics Screwdriver Set



FEATURES:

- Transparent box for easy storage and convenient carrying.
- Ergonomical handle provides firm and comfortable grips.
- Specification mark is easy to read.
- Meets or exceeds ANSI standards.

CONTAINS:

- 2pc phillips: PH0, PH1
- 4pc slotted: 1.4, 2, 2.4, 3mm

ITEM	Packaging	Box/carton	Gw/Nw(kg)	MEAS(cm)
YJPS-355D	Double Blister	12/60	10.2/9.2	59*26*42.5

YJPS-354

9pcs Precision Screwdriver Set



FEATURES:

- Transparent box for easy storage and convenient carrying.
- Ergonomical handle provides firm and comfortable grips.
- Specification mark is easy to read.
- Meets or exceeds ANSI standards.

CONTAINS:

- 9pc torx: T4, T5, T6, T7, T8, T9, T10, T15, T20

ITEM	Packaging	Box/carton	Gw/Nw(kg)	MEAS(cm)
YJPS-354D	Sliding card	10/60		43.5*29.5*39.5

YJPS-357

20pcs Electronics Bit Driver Set



FEATURES:

- CR-V bits with phosphating treatment.
- Swivelling base for one-hand operation and better control.
- Transparent box for easy storage and convenient carrying.
- Ergonomical handle provides firm and comfortable grips.

CONTAINS:

- 6pc slotted: 1, 1.5, 2, 2.5, 3, 4mm
- 4pc phillips: PH000, PH00, PH0, PH1
- 2pc pozi: PZ0, PZ1
- 8pc torx: T5, T6, T7, T8, T9, T10, T15, T20
- 1pc screwdriver handle

ITEM	Packaging	Box/carton	Gw/Nw(kg)	MEAS(cm)
YJPS-357B	Bulk	12/60	11.7/10.7	59*26*42.5

YJPS-359

30-in-1 Screwdriver Bit Set



FEATURES:

- CR-V bits with phosphating treatment
- Swivelling base for one-hand operation and better control.
- Durable alloy steel with coated shafts.

CONTAINS:

- 9pc torx: T4, T5, T6, T7, T8, T9, T10, T15, T20
- 7pc slotted: 1.0, 1.2, 2.0, 2.5, 3.0, 3.5, 4.0mm
- 4pc phillips: PH000, PH00, PH0, PH1
- 8pc hex: 0.7, 0.9, 1.3, 1.5, 2.0, 2.5, 3.0, 4.0mm
- 1pc bits holder
- 1pc screwdriver handle

ITEM	Packaging	Box/carton	Gw/Nw(kg)	MEAS(cm)
YJPS-359B	Bulk	10/60	15.5/14.5	43.5*29.5*39.5

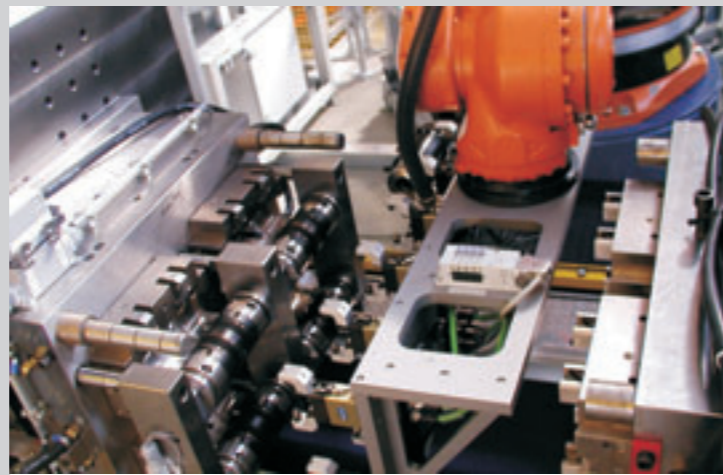

YJPS-364

12-in-1 Precision Screwdriver Set



FEATURES:

- Soft handle with rotating cap.
- Double-ended CR-V blades.
- Surface: chrome finish blade with black tip.

CONTAINS:

- 1.5mm/PH00, 2.5mm/PH0, 3.0mm/PH1, T9/T6, 1.5mm/T7, 2.0mm/T8

ITEM	Packaging	Box/carton	Gw/Nw(kg)	MEAS(cm)
YJPS-364B	Bulk	12/72	11.2/10.2	52.5*24*42

YJPS-365

6-in-1 Precision Screwdriver Set



FEATURES:

- Soft handle.
- Double-ended CR-V blades.
- Surface: chrome finish.

CONTAINS:

- 1.5mm/PH00, 2.5mm/PH0, 3.0mm/PH1

ITEM	Packaging	Box/carton	Gw/Nw(kg)	MEAS(cm)
YJPS-365B	Bulk	10/40	4.3/3.3	35.5*31.5*18

YJPS-6250

11pcs Precision Screwdriver & Bits Set



CONTAINS:

- 1pc 1/4 bits holder
- 4pc torx: T3, T4, T5, T6
- 2pc phillips: PH00, PH0
- 1pc slotted: 1.4mm
- 1pc triwing: Y#0
- 1pc five pointed star bit: 2.0

YJPS-6251

11pcs Precision Screwdriver & Bits Set



CONTAINS:

- 1pc speedfit
- 1pc 1/4 bits holder
- 3pc spanner slotted: U6, U8, U10
- 3pc torx: T15, T20, T25
- 3pc hex: H2, H3, H4

YJPS-6251

11pcs Precision Screwdriver & Bits Set



CONTAINS:

- 1pc speedfit
- 1pc 1/4 bits holder
- 3pc slotted: 4.0mm, 5.0mm, 6.0mm
- 3pc phillips: PH1, PH2, PH3
- 3pc pozi: PZ1, PZ2, PZ3

YJPS-358

8pcs Precision Screwdriver Set With Tweezers



FEATURES:

- Transparent box for easy storage and convenient carrying.
- Ergonomical handle provides firm and comfortable grips.
- Specification mark is easy to read.
- Meets or exceeds ANSI standards.

CONTAINS:

- 3pc phillips: PH00, PH0, PH1
- 2pc slotted: 2.0, 3.0mm
- 3pc torx: T5, T6, T7

ITEM	Packaging	Box/carton	Gw/Nw(kg)	MEAS(cm)
YJPS-358B	Bulk	5/40	11.3/10.3	46*33.5*30.5



PLIERS AND WRENCHES

LONGYUAN TOOLS manufactures technical pliers and wrenches, mainly to produce stamping type. Product main types of pliers have wire crimpers and wire strippers. Pliers are all made of heat treated alloy steel, which strength its higher operation efficiency and longer life for application.



As a leading specialist, LONGYUAN TOOLS always puts the quality first; all products are in strict accordance with TUV/GS standard, which become the foreign customers' favorites.

HOTAK

Our Instrument is always specialized in the plier's productions. with continuous investment in technology research and professional team, we are gradually upgrading our creative products to rich variety of products. After nearly 10 years of pliers' production and improvement, our team summarizes a series of experience of pliers and wrenches in the production, usage, criterion, testing, and creates product more professional and ease of use.



YJTS-2990

Cut Aviation Snips

FEATURES:

- Cuts up to 18ga (1.2mm) cold-rolled steel or 22ga (0.7mm) stainless steel.
- Self opening safety lock for fast one handed operation.
- Serrated jaws, induction hardened cutting edge stays sharp longer.
- Comfort grip handle.
- 45° offset head design.



YJTS-2991

Cut Aviation Snips

FEATURES:

- Cuts up to 18ga (1.2mm) cold-rolled steel or 22ga (0.7mm) stainless steel.
- Self opening safety lock for fast one handed operation.
- Serrated jaws, induction hardened cutting edge stays sharp longer.
- Comfort grip handle.



YJTS-2992

Cut Aviation Snips

FEATURES:

- Cuts up to 18ga (1.2mm) cold-rolled steel or 22ga (0.7mm) stainless steel.
- Self opening safety lock for fast one handed operation.
- Serrated jaws, induction hardened cutting edge stays sharp longer.
- Comfort grip handle.
- 45° offset head design.



Serrated blade edge provides non-slip cutting.



Self-opening design for one hand operation and easy of storage.



Induction hardened cutting edge stays sharp longer.



YJTS-2650

Double Sided Pipe Wrench

FEATURES:

- All metal construction.
- One hand operation for various of jobs.
- Quick release, self adjustable ratcheting action.
- Special angled tooth design.
- Easy to grip by placing it on the item or material and pull.
- Pull up the jaw or move it the opposite direction to release.
- Opening width: 8-24mm, 16-36mm.
- Apply to copper, PVC, galvanized pipes etc.



YJTS-2640

Heavy Duty Auto Adjustable Pipe Wrench

FEATURES:

- Spring loaded jaw allows the wrench to ratchet, turning pipes more quickly and in confined spaces.
- Ergonomic grip handle for extra comfort and strength.
- One-hand operation, adjust to pipe sizes quickly to suit your applications.



The minimum capacity of the diameter: 16mm

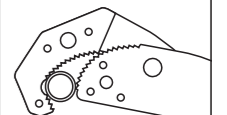

Maximum capacity diameter: 36mm

YJTS-2645

Heavy Duty Auto Adjustable Pipe Wrench

FEATURES:

- Spring loaded jaw allows the wrench to ratchet, turning pipes more quickly and in confined spaces.
- Ergonomic grip handle for extra comfort and strength.
- One-hand operation, adjust to pipe sizes quickly to suit your applications.



The minimum capacity of the diameter: 16mm

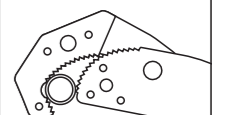

Maximum capacity diameter: 36mm

YJTS-2342

Wire Crimper / Stripper

FEATURES:

- Strips and cuts solid and stranded wire, sk5 body for maximum sharp.
- Ergonomic, cushioned handles for ultimate comfort and control.
- Double bevel cutting blades for better performance.
- Wire looping holes form wire to knurled pliers nose for gripping And pulling.
- Surface: black finish
- Bolt size: 6-32, 8-32, 10-32, 4-40, 10-24, 5-40.



ITEM	Packaging	Box/carton	Gw/Nw(kg)	MEAS(cm)
YJTS-2342F	Try-me double blister	6/24	6/5	36*27.5*29.5

YJTS-2343

Wire Cutter

FEATURES:

- Bi-layer handle provides added structure, superior palm-fit, and comfort.
- Strips and cuts solid and stranded wire, SK5 body for maximum sharp.
- Double bevel cutting blades for better performance.
- Wire looping holes form wire to Knurled pliers nose for gripping and pulling.
- Surface: black Finish.
- Bolt size: 10, 12, 14, 16, 18.



ITEM	Packaging	Box/carton	Gw/Nw(kg)	MEAS(cm)
YJTS-2343F	Try-me double blister	6/24	4.6/3.6	31.5*27.5*25.5

YJTS-2344

Wire Cutter

FEATURES:

- Bi-layer handle provides added structure, superior palm-fit, and comfort.
- Strips and cuts solid and stranded wire, SK5 body for maximum sharp.
- Double bevel cutting blades for better performance.
- Wire looping holes form wire to Knurled pliers nose for gripping and pulling.
- Surface: black Finish.
- Bolt size: 16, 18, 20, 22, 24, 26.



ITEM	Packaging	Box/carton	Gw/Nw(kg)	MEAS(cm)
YJTS-2344F	Try-me double blister	6/24	4.7/3.7	31.5*27.5*25.5

YJTS-2953

6" Wire Stripper Pliers

FEATURES:

- Drop forged, heat treated steel, baked black enamel finish for durability. Screened sizes and applications.
- Comfort grip handle.
- Self-opening, spring-loaded hinge with safety lock.
- Built-in wire&cable cutter.
- Quickly strips 10-22 AWG(0.6-2.6mm) wire, quickly remove insulation without damage to wire.
- Cut copper and aluminum wire only(not for use with steel wire).

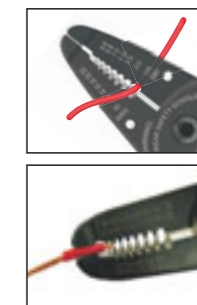

YJTS-2954

7" Wire Stripper And Cutter Pliers

FEATURES:

- Ergonomic single curve handle design for more comfortable grip and better leverage.
- Self-opening, spring-loaded hinge with safety lock.
- Strip solid (10-20 AWG) and stranded (12-22 AWG) wire.
- Serrated pliers jaw grips, pulls, and twists wire.
- Shear-type wire cutter. Cut screws sizes #8-32 and #10-32.
- Looping holes bend wire ends to fit around screw terminals.



YJTS-2955

8" Wire Striping/crimping Pliers

FEATURES:

- Drop forged, heat treated steel, baked black enamel finish for durability. Screened sizes and applications.
- Made of drop-forged and heat treated, high carbon steel.
- Comfort grip handle.
- Built-in wire&cable cutter.
- Easily crimps insulated and non-insulated terminals.
- Pro-grade for auto wiring and electrical work:
 - Strips wires: AWG 12-24
 - Cuts wires: AWG 10-22
- Crimps both insulated and non-insulated connections:
 - Screw cutter for 5/40, 10/24, 4/40, 10/32, 8/32, 6/32.
- Not-slip cushion grip handle.
- High-contrast size range markings.



YJTS-2958

6" Coax Wire Stripper And Cutter Pliers

FEATURES:

- Drop forged, heat treated steel, baked black enamel finish for durability.
- Screened sizes and applications.
- Comfort grip handle.
- Self-opening, spring-loaded hinge with safety lock.
- Built-in wire&cable cutter.
- Quickly strips 8-14 AWG wire, quickly remove insulation without damage to wire. Cuts screws diameter under 3MM.



HOTAK

YJTS-2960

7" crimp Pliers

FEATURES:

- Drop forged, heat treated steel, baked black enamel finish for durability.
- Screened sizes and applications.
- Comfort grip handle.
- Self-opening, spring-loaded hinge with safety lock.
- Built-in wire & cable cutter, special tip for crimping terminals & connectors.
- Quickly strips 10-12 AWG(0.6-2.0mm) wire, quickly remove insulation without damage to wire.
- Crimps 10-20 AWG(0.6-2.6mm) non-insulated terminals, crimps 14-28, AWG(0.3-1.6mm) insulated terminals.
- Cut copper and aluminum wire only(not for use with steel wire).

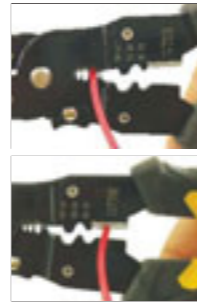

YJTS-2956

8-1/2-inch Wire Stripper/crimper Pliers

FEATURES:

- Drop forged, heat treated steel, baked black enamel finish for durability.
- Screened sizes and applications.
- Made of drop-forged and heat treated, high carbon steel.
- Comfort grip handle.
- Built-in wire&cable cutter.
- Cuts and threads popular bolt sizes: 4-40, 6-32, 8-32, 10-24, 10-32.
- Crimps non-insulated 7-mm to 8-mm auto ignition wire.
- Strips stranded 8-22 AWG wire, strips solid 10-26 AWG wire.
- Crimps insulated terminals for 10-26 AWG.
- Crimps non-insulated terminals for 10-22 AWG.

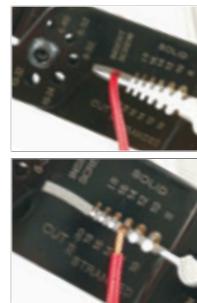

YJTS-2963

8-1/2-inch Wire Stripper/crimper Pliers

FEATURES:

- Drop forged, heat treated steel, baked black enamel finish for durability.
- Screened sizes and applications.
- Made of drop-forged and heat treated, high carbon steel.
- Comfort grip handle.
- Built-in wire&cable cutter.
- Cuts and threads popular bolt sizes: 4-40, 6-32, 8-32, 10-24, 10-32.
- Crimps non-insulated 7-mm to 8-mm auto ignition wire.
- Strips stranded 10-20 AWG wire, strips solid 8-18 AWG wire.
- Crimps insulated terminals for 10-12, 14-22 AWG.
- Crimps non-insulated terminals for 10-22 AWG.

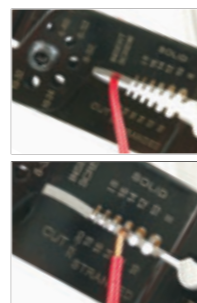

YJTS-2349

Wire Cutter

FEATURES:

- Ergonomic grip for easy operation.
- Handy closure lock for convenient storage.
- Bi-layer handle provides added structure, superior palm-fit, and comfort.
- Spring-loaded action for self-opening.
- Surface: black Finish



YJTS-2550

7in. Self-adjusting Pliers

FEATURES:

- Perfect for auto, home & workshop!
- Jaws auto-adjust with one hand operation.
- Combo straight & v-jaw grips hex, square & round objects.
- Layered steel construction for added strength.
- Non-slip shaped cushioned grips for comfort.
- 11/8in./35mm opening/ouverture/aperture

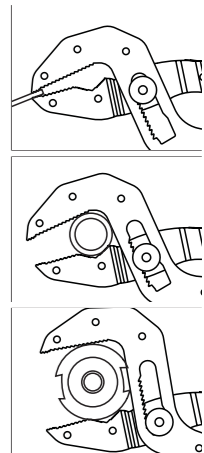
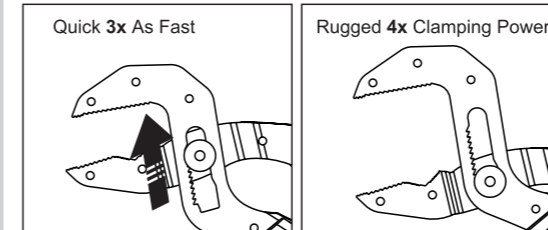

YJTS-2551

10in. Self-adjusting Pliers

FEATURES:

- Perfect for auto, home & workshop!
- Jaws auto-adjust with one hand operation.
- Combo straight & v-jaw grips hex, square & round objects.
- Layered steel construction for added strength.
- Non-slip shaped cushioned grips for comfort.
- 19/8in./60mm opening/ouverture/aperture.

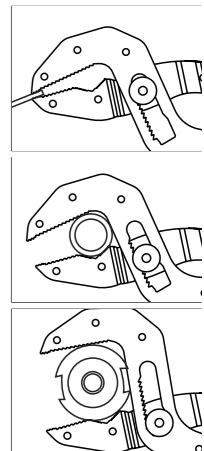
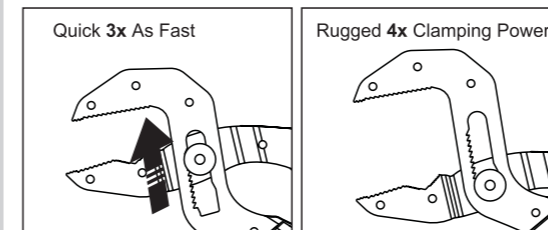

YJTS-2170

Heavy Riveter With 4 Nosepieces

FEATURES:

- Smooth, easy, one-handed operation.
- Chrome moly jaws.
- Aluminum alloy construction with ergonomic grip handle.
- Spring loaded handle ejects rivet stem automatically.
- One wrench stored in handle.

SIZE:

- 2.4, 3.2, 4.0, 4.8mm

ITEM	Packaging	Box/carton	Gw/Nw(kg)	MEAS(cm)
YJTS-2170D	Double blister	6/24	16.8/15.8	37*35.5*45.5



YJTS-2501

Muti-punch Set

FEATURES:

- Ergonomic, non-slip handles with cushioning for added comfort.
- Punches and sets eyelets, snaps, and so much more.
- Size: for 5mm grommet.

APPLICATION:

- Easily punch through any material, thick or thin: paper, leather, plastic, metal, chipboard, acrylic, fabric, wood, and so on.

ITEM	Packaging	Box/carton	Gw/Nw(kg)	MEAS(cm)
YJTS-2501D	Double blister	6/24	9.4/8.4	37*31.3*41.5



YJTS-2502

Muti-punch Set

FEATURES:

- Ergonomic, non-slip handles with cushioning for added comfort.
- Punches and sets eyelets, snaps, and so much more.
- Size: for 7mm grommet.

APPLICATION:

- Easily punch through any material, thick or thin: paper, leather, plastic, metal, chipboard, acrylic, fabric, wood, and so on.

ITEM	Packaging	Box/carton	Gw/Nw(kg)	MEAS(cm)
YJTS-2502D	Double blister	6/24	9.4/8.4	37*31.3*41.5



YJTS-2503

Muti-punch Set

FEATURES:

- Ergonomic, non-slip handles with cushioning for added comfort.
- Punches and sets eyelets, snaps, and so much more.
- Size: for 8mm grommet.

APPLICATION:

- Easily punch through any material, thick or thin: paper, leather, plastic, metal, chipboard, acrylic, fabric, wood, and so on.

ITEM	Packaging	Box/carton	Gw/Nw(kg)	MEAS(cm)
YJTS-2503D	Double blister	6/24	9.4/8.4	37*31.3*41.5



YJTS-2504

Muti-punch Set

FEATURES:

- Ergonomic, non-slip handles with cushioning for added comfort.
- Punches and sets eyelets, snaps, and so much more.
- Size: for 12mm grommet.

APPLICATION:

- Easily punch through any material, thick or thin: paper, leather, plastic, metal, chipboard, acrylic, fabric, wood, and so on.

ITEM	Packaging	Box/carton	Gw/Nw(kg)	MEAS(cm)
YJTS-2504D	Double blister	6/24	9.4/8.4	37*31.3*41.5



Interchangeable setting pieces for different size grommets.



Load plier from the edge of material, punch head confronts the exposed grommet cover.



Load grip and fix grommet into material, make sure not burs and clear edge.

YJTS-2285

Coaxial Crimping Tool

FEATURES:

- High precision terminal crimping hole, moderate pressure terminal in the wires and no damage to terminal.
- Pressure adjusting button design. It's suitable for various terminals. It is designed specially when the handle is pressured and the jaw can be opened.
- It's made of high carbon steel and comfortable TPR handle to prevent deformation and bending.
- Crimping Range: 1.72, 2.6, 5.4, 6.5, 8.1mm.

ITEM	Packaging	Box/carton	Gw/Nw(kg)	MEAS(cm)
YJTS-2285D	Double blister	6/24	16.4/15.4	37.5*30*37.5



YJTS-2286

Insulated Terminal Crimping Tool

FEATURES:

- High precision terminal crimping hole, moderate pressure terminal in the wires and no damage to terminal.
- Pressure adjusting button design. It's suitable for various terminals. It is designed specially when the handle is pressured and the jaw can be opened.
- It's made of high carbon steel and comfortable TPR handle to prevent deformation and bending.
- Crimping Range: 0.5-6mm.

ITEM	Packaging	Box/carton	Gw/Nw(kg)	MEAS(cm)
YJTS-2286D	Double blister	6/24	16.4/15.4	37.5*30*37.5



YJTS-2287

Uninsulated Open Brass Terminal Crimping Tool

FEATURES:

- High precision terminal crimping hole, moderate pressure terminal in the wires and no damage to terminal.
- Pressure adjusting button design. It's suitable for various terminals. It is designed specially when the handle is pressured and the jaw can be opened.
- It's made of high carbon steel and comfortable TPR handle to prevent deformation and bending.
- Crimping Range: 0.5-6mm.

ITEM	Packaging	Box/carton	Gw/Nw(kg)	MEAS(cm)
YJTS-2287D	Double blister	6/24	16.4/15.4	37.5*30*37.5



YJTS-2288

Uninsulated Terminal Crimping Tool

FEATURES:

- High precision terminal crimping hole, moderate pressure terminal in the wires and no damage to terminal.
- Pressure adjusting button design. It's suitable for various terminals. It is designed specially when the handle is pressured and the jaw can be opened.
- It's made of high carbon steel and comfortable TPR handle to prevent deformation and bending.
- Crimping Range: 0.5-10mm.

ITEM	Packaging	Box/carton	Gw/Nw(kg)	MEAS(cm)
YJTS-2288D	Double blister	6/24	16.4/15.4	37.5*30*37.5



YJTS-2289

European-style Terminal Crimping Tool

FEATURES:

- High precision terminal crimping hole, moderate pressure terminal in the wires and no damage to terminal.
- Pressure adjusting button design. It's suitable for various terminals. It is designed specially when the handle is pressured and the jaw can be opened.
- It's made of high carbon steel and comfortable TPR handle to prevent deformation and bending.
- Crimping Range: 0.5-6mm.

ITEM	Packaging	Box/carton	Gw/Nw(kg)	MEAS(cm)
YJTS-2289D	Double blister	6/24	16.4/15.4	37.5*30*37.5





YJTS-2101

High Quality Pipe Wrench

FEATURES:

- Delicate appearance and measure is convenient to be carried and used.
- Release button, single hand operation.
- Steel construction for maximum performance.
- Convenient for use in small places or corners.
- Opening width: 13-38mm(1/2-3/2).

ITEM	Packaging	Box/carton	Gw/Nw(kg)	MEAS(cm)
YJTS-2101G	Half blister	4/12	14.8/13.8	48*47*16

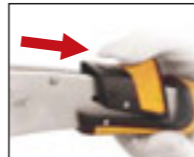

YJTS-2102

High Quality Pipe Wrench

FEATURES:

- Delicate appearance and measure is convenient to be carried and used.
- Release button, single hand operation.
- Steel construction for maximum performance.
- Convenient for use in small places or corners.
- Opening width: 6-25mm(1/4-1).

ITEM	Packaging	Box/carton	Gw/Nw(kg)	MEAS(cm)
YJTS-2102G	Half blister	6/24	12.5/11.5	35.5*25.5*37.5



YJTS-2103

High Quality Nut Wrench

FEATURES:

- Delicate appearance and measure is convenient to be carried and used.
- Release button, single hand operation.
- Steel construction for maximum performance.
- Convenient for use in small places or corners.
- Opening width: 13-24mm(1/2-15/16).

ITEM	Packaging	Box/carton	Gw/Nw(kg)	MEAS(cm)
YJTS-2103G	Half blister	6/24	9/8	35.5*25.5*37.5



YJTS-2104

High Quality Nut Wrench

FEATURES:

- Delicate appearance and measure is convenient to be carried and used.
- Release button, single hand operation.
- Steel construction for maximum performance.
- Convenient for use in small places or corners.
- Opening width: 10-19mm(3/8-3/4).

ITEM	Packaging	Box/carton	Gw/Nw(kg)	MEAS(cm)
YJTS-2104G	Half blister	8/32	6.6/5.6	40*22.5*27.5



YJTS-2108

High Quality Nut Wrench Set

FEATURES:

- Delicate appearance and measure is convenient to be carried and used.
- Release button, single hand operation.
- Steel construction for maximum performance.
- Convenient for use in small places or corners.

ITEM	Packaging	Box/carton	Gw/Nw(kg)	MEAS(cm)
YJTS-2108D	Double blister	4/24	15/14	58.5*38*32



13-24mm(1/2-15/16)
+
10-19mm(3/8-3/4)



YJTS-420

Automatic Wire Stripper& Crimper

FEATURES:

- Strips wire from 10-24 AWG, adjustable stopper controls the length of the core strip.
- Swivel knob micro-adjusts for gauges smaller than 20 AWG.
- Wire crimper crimps 10-22 AWG insulated, 10-22 AWG non-insulated and 7-9mm ignition terminals.
- Wire cutter extends versatility.

APPLICATION:

- This revolutionary tool makes repair and assembly projects more efficient for home or professional users. You may find our stripper make stripping faster and safer than ever. It is ideal for home, garage, marine or regular use.

ITEM	Packaging	Box/carton	Gw/Nw(kg)	MEAS(cm)
YJTS-420G	Half blister	6/24	9/8	31*28.5*35.5
YJTS-420D	Double blister	6/24	10/9	35.5*33.5*41.5



YJTS-421

Automatic Wire Stripper& Crimper

FEATURES:

- High quality blade performs efficient cutting.
- For all of wire from 10 AWG to 24 AWG(0.2-6.0mm).
- The cutter made by precision coating(HRC40-55).
- For non-insulated terminals 12-22AWG(0.5-6.0mm).
- For insulated terminals 8-22AWG(0.5-8.0mm).

APPLICATION:

- This revolutionary tool makes repair and assembly projects more efficient for home or professional users. You may find our stripper make stripping faster and safer than ever. It is ideal for home, garage, marine or regular use.

ITEM	Packaging	Box/carton	Gw/Nw(kg)	MEAS(cm)
YJTS-421G	Half blister	6/24	9/8	31*28.5*35.5
YJTS-421D	Double blister	6/24	10/9	35.5*33.5*41.5



YJTS-422

Automatic Wire Stripper& Crimper

FEATURES:

- High quality blade performs efficient cutting.
- For all of wire from 10 AWG to 24 AWG(0.2-6.0mm).
- The cutter made by precision coating(HRC40-55).
- For non-insulated terminals 12-22AWG(0.5-6.0mm).
- For insulated terminals 8-22AWG(0.5-8.0mm).

APPLICATION:

- This revolutionary tool makes repair and assembly projects more efficient for home or professional users. You may find our stripper make stripping faster and safer than ever. It is ideal for home, garage, marine or regular use.

ITEM	Packaging	Box/carton	Gw/Nw(kg)	MEAS(cm)
YJTS-422G	Half blister	6/24	9/8	31*28.5*35.5
YJTS-422D	Double blister	6/24	10/9	35.5*33.5*41.5

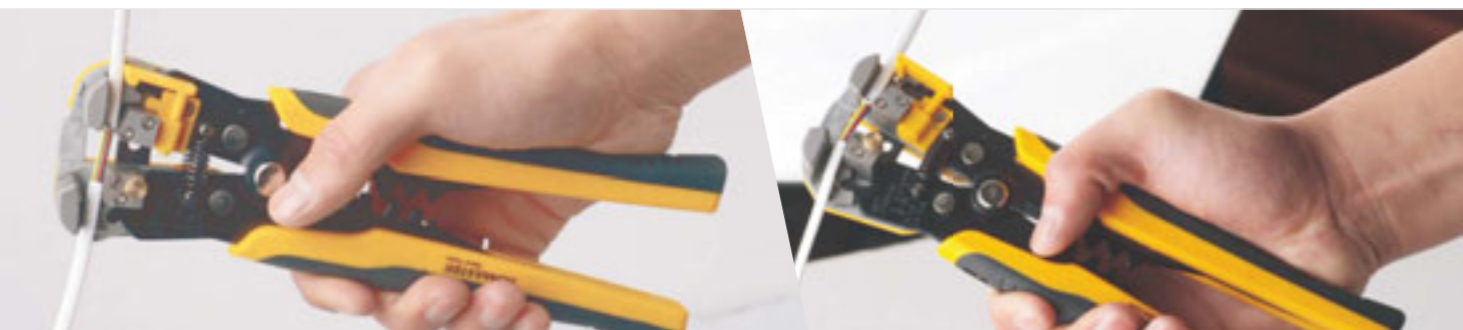

YJTS-414G

2 In 1 Modular Telephone Plug Crimper

APPLICATION:

- For cuts-strips-crimps 2 type of plug in 1.
- Embedded cable cutter and stripper.
- Ergonomical ratcheting frame with 24pc telephone plug/8P/6P.
- Crimps, strips and cuts in one tool.
- Comfortable grip handle.
- Built-in-safety ratchet release.

ITEM	Packaging	Box/carton	Gw/Nw(kg)	MEAS(cm)
YJTS-414G	Half blister	8/32	10/9	56.5*40.5*27.5



YJTS-414D

2 In 1 Modular Telephone Plug Crimper

APPLICATION:

- For cuts-strips-crimps 2 type of plug in 1.
- Embedded cable cutter and stripper.
- Ergonomical ratcheting frame with 24pc telephone plug/8P/6P.
- Crimps, strips and cuts in one tool.
- Comfortable grip handle.
- Built-in-safety ratchet release.

ITEM	Packaging	Box/carton	Gw/Nw(kg)	MEAS(cm)
YJTS-414D	Double blister	6/24	10.7/9.7	48.5*29*38.5



YJTS-415

2 In 1 Modular Telephone Plug Crimper

APPLICATION:

- For cuts-strips-crimps 2 type of plug in 1.
- Embedded cable cutter and stripper.
- Ergonomical ratcheting frame with 24pc telephone plug/8P/6P.
- Crimps, strips and cuts in one tool.
- Comfortable grip handle.
- Built-in-safety ratchet release.

ITEM	Packaging	Box/carton	Gw/Nw(kg)	MEAS(cm)
YJTS-415D	Double blister	6/24	9.2/8.2	39.5*31*40.5





YJTS-404

6pcs Metric Combination Ratchet Wrench Set

FEATURES:

- CR-V steel for long life, durability and toughness.
- Excellent set any home or auto mechanic must have.
- Surface: satin finish.
- Contains: 8, 10, 12, 13, 14, 17mm.



ITEM	Packaging	Box/carton	Gw/Nw(kg)	MEAS(cm)
YJTS-404B	Shrink	6/12	9/8	31*25.5*32.5

YJTS-405

6pcs SAE Combination Ratchet Wrench Set

FEATURES:

- CR-V steel for long life, durability and toughness.
- Excellent set any home or auto mechanic must have.
- Surface: satin finish.
- Contains: 5/16", 3/8", 7/16", 1/2", 11/16", 9/16".



ITEM	Packaging	Box/carton	Gw/Nw(kg)	MEAS(cm)
YJTS-405B	Shrink	6/12	9/8	31*25.5*32.5

YJTS-405

5pcs Metric Combination Ratchet Wrench Set

FEATURES:

- CR-V steel for long life, durability and toughness.
- Excellent set any home or auto mechanic must have.
- Surface: satin finish.
- Contains: 8, 10, 12, 13, 17mm.



ITEM	Packaging	Box/carton	Gw/Nw(kg)	MEAS(cm)
YJTS-423D	Double blister	6/12	10.5/9.5	50.5*29*15.55

YJTS-407

5pcs Metric Combination Ratchet Wrench Set

FEATURES:

- CR-V steel for long life, durability and toughness.
- Excellent set any home or auto mechanic must have.
- Surface: satin finish.
- Contains: 19x21, 14x15, 12x13, 9x10, 7x8mm.



ITEM	Packaging	Box/carton	Gw/Nw(kg)	MEAS(cm)
YJTS-407D	Double blister	5/10	10/9	42.5*29*27.5

YJTS-2009

2-in-1 Self-Adjusting & locking Pliers(6")

FEATURES:

- High quality carbon steel, exceptional elasticity combined with a high degree of hardness.
- Non-slip TPR handle with ergonomic angle.
- Force saving and stable, long service life.
- Extremely shock-resistant for heavy-duty use and maximum demands.



ITEM	Packaging	Box/carton	Gw/Nw(kg)	MEAS(cm)
YJTS-2009D	Double blister	6/24	8.2/7.2	43*30*26.5

YJTS-2011

2-in-1 Self-Adjusting & locking Pliers(8")

FEATURES:

- High quality carbon steel, exceptional elasticity combined with a high degree of hardness.
- Non-slip TPR handle with ergonomic angle.
- Force saving and stable, long service life.
- Extremely shock-resistant for heavy-duty use and maximum demands.



ITEM	Packaging	Box/carton	Gw/Nw(kg)	MEAS(cm)
YJTS-2011D	Double blister	6/24	14/13	33.5*30.5*32.5

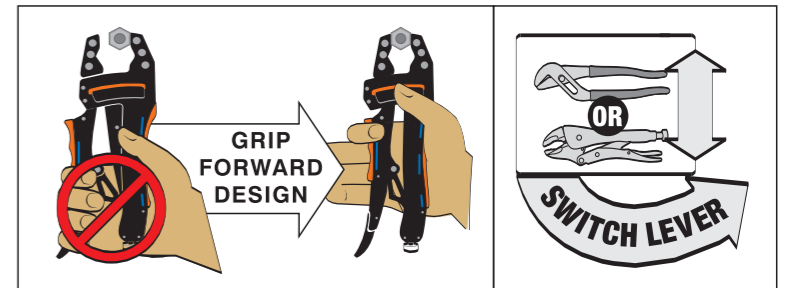

YJTS-2055

Grommet Setting Tool

FEATURES:

- Grommet setting tool is made of drop forged steel and heat treated pliers have comfortable handles for easy grip.
- Ergonomic handles.
- Surface: chrome-plated handle.



ITEM	Packaging	Box/carton	Gw/Nw(kg)	MEAS(cm)
YJTS-2055D	Double blister	10/60	10/9	49*26*42.5

YJTS-2056

Grommet Setting Tool

FEATURES:

- Grommet setting tool is made of drop forged steel and heat treated pliers have comfortable handles for easy grip.
- Ergonomic handles.
- Surface: rubber coating handle.



ITEM	Packaging	Box/carton	Gw/Nw(kg)	MEAS(cm)
YJTS-2056D	Double blister	10/60	10/9	49*26*42.5

YJTS-2018

Leather Hole Punch

APPLICATION:

- Pivoting Jaw ends, auto-release feature, ergonomic handles.
- Hole punch tool has interchangeable punch heads punches clean and neat holes in leather and other soft materials.
- Hole punch and grommet setting tool is made of drop forged steel.
- Surface: chrome-plated handle.



CONTAINS:

- 2.5mm, 3mm, 3.5mm, 4mm, 4.5mm, 5mm.

ITEM	Packaging	Box/carton	Gw/Nw(kg)	MEAS(cm)
YJTS-2018G	Half blister	6/24	8/7	32*27.5*37.5
YJTS-2019D	Double blister	12/48	16/15	35.5*33.5*41.5

YJTS-2019

Leather Hole Punch

APPLICATION:

- Pivoting Jaw ends, auto-release feature, ergonomic handles.
- Hole punch tool has interchangeable punch heads punches clean and neat holes in leather and other soft materials.
- Hole punch and grommet setting tool is made of drop forged steel.
- Surface: rubber coating handle.



CONTAINS:

- 2.5mm, 3mm, 3.5mm, 4mm, 4.5mm, 5mm.

ITEM	Packaging	Box/carton	Gw/Nw(kg)	MEAS(cm)
YJTS-2019G	Half blister	6/24	8/7	32*27.5*37.5
YJTS-2019D	Double blister	12/48	16/15	35.5*33.5*41.5



YJTS-2002

Leather Hole Punch & Grommet Setting Tool Kit

FEATURES:

- Pivoting Jaw ends, auto-release feature, ergonomic handles.
- Hole punch tool has interchangeable punch heads punches clean and neat holes in leather and other soft materials.
- Hole punch and grommet setting tool is made of drop forged steel.
- Surface: chrome-plated handle

CONTAINS:

- 1pc grommet setting tool
- 1pc leather hole punch
Punch hole sizes: 2.5mm, 3mm, 3.5mm, 4mm, 4.5mm, 5mm.
- 100pc shoe or belt grommets.

ITEM	Packaging	Box/carton	Gw/Nw(kg)	MEAS(cm)
YJTS-2002D	Double blister	6/24	13.4/12.4	53*34.3*45.5



YJTS-2003

Leather Hole Punch & Grommet Setting Tool Kit

FEATURES:

- Pivoting Jaw ends, auto-release feature, ergonomic handles.
- Hole punch tool has interchangeable punch heads punches clean and neat holes in leather and other soft materials.
- Hole punch and grommet setting tool is made of drop forged steel.
- Surface: rubber coating handle.

CONTAINS:

- 1pc grommet setting tool
- 1pc leather hole punch
Punch hole sizes: 2.5mm, 3mm, 3.5mm, 4mm, 4.5mm, 5mm.
- 100pc shoe or belt grommets.

ITEM	Packaging	Box/carton	Gw/Nw(kg)	MEAS(cm)
YJTS-2003D	Double blister	6/24	13.4/12.4	53*34.3*45.5





YJTS-431

Leather Hole Punch & Grommet Setting Tool Kit

FEATURES:

- Pivoting Jaw ends, auto-release feature, ergonomic handles.
- Hole punch tool has interchangeable punch heads punches clean and neat holes in leather and other soft materials.
- Hole punch and grommet setting tool is made of drop forged steel.
- Surface: chrome-plated handle.

CONTAINS:

- 1pc button tool
- 1pc grommet setting tool
- 1pc leather hole punch
- Punch hole sizes: 2.5mm, 3mm, 3.5mm, 4mm, 4.5mm, 5mm.
- 100pc shoe or belt grommets and 50pcs penta-claw button.



ITEM	Packaging	Box/carton	Gw/Nw(kg)	MEAS(cm)
YJTS-431D	Double blister	6/24	16.4/15.4	56.5*31*35.5

YJTS-432

Leather Hole Punch & Grommet Setting Tool Kit

FEATURES:

- Pivoting Jaw ends, auto-release feature, ergonomic handles.
- Hole punch tool has interchangeable punch heads punches clean and neat holes in leather and other soft materials.
- Hole punch and grommet setting tool is made of drop forged steel.
- Surface: rubber coating handle.

CONTAINS:

- 1pc button tool
- 1pc grommet setting tool
- 1pc leather hole punch
- Punch hole sizes: 2.5mm, 3mm, 3.5mm, 4mm, 4.5mm, 5mm.
- 100pc shoe or belt grommets and 50pcs penta-claw button.



ITEM	Packaging	Box/carton	Gw/Nw(kg)	MEAS(cm)
YJTS-432D	Double blister	6/24	16.4/15.4	56.5*31*35.5

YJTS-2068

8pcs Compact Ratchet Wrench Set

FEATUES:

- Ergonomic, non-conductive handle.
- Including eight sockets and 2 bits.
- Sockets can be stored inside the handle.
- Light weight, durable high torque.
- Chrome plated sockets to resist rust.

CONTAINS:

- 1pc slotted: 5.0 mm
- 1pc phillips: PH1
- 6pc sockets: 5.0, 6.0, 7.0, 8.0, 9.0, 10.0mm.

ITEM	Packaging	Box/carton	Gw/Nw(kg)	MEAS(cm)
YJTS-2068D	Double blister	6/24	7/6	57*25.5*36



YJTS-2420

5pcs Mini Needle File Set

FEATURES:

- These unique, versatile and compact tool sets are designed for intricate work on carvings and other fine detailing.
- The sure grip anodized handle acts as a storage compartment for the files and screw driver sets.
- The quick adjust collet secures the tips tightly.

CONTAINS:

- 1pc aluminum holder
- 5pc different file: 1pc triangle file
1pc square
1pc round
1pc half-Round
1pc slotted



YJTS-2830

21pcs Ratchet Screwdriver And Socket Set

FEATURES:

- Heavy duty bi-material ergonomic grip handle for greater control, comfort and torque.
- The ratchet drive handle reverses instantly for clockwise and counter-clockwise rotation.
- CR-V bits and chrome plated sockets for long life time use.

CONTAINS:

- 1pc 1/4in. ratchet handle
- 1pc 1/4in. socket adaptor
- 10pc 1/4in. hardened tempered alloy steel bits:
 - 2pc phillips: PH1, PH2
 - 2pc slotted: 4.0mm, 5.0mm
 - 2pc pozi: PZ1, PZ2
 - 2pc hex: 4.0, 5.0mm
 - 2pc torx: T15, T20
- 9pc sockets: 5, 6, 7, 8, 9, 10, 11, 12, 13mm



YJTS-425

1/4" Ratchet Handle

FEATURES:

- Ratchet handle and sockets exceed national specifications for torque.
- Ratchet handle that is ready for many uses.
- Standard sizes snap-in locking socket tray.
- Ergonomic shaft for better grip.
- CR-V sockets for long lasting.
- Surface: satin finish.

CONTAINS:

- 7pc 1/4" sockets-6, 7, 8, 9, 10, 11, 13mm.

ITEM	Packaging	Box/carton	Gw/Nw(kg)	MEAS(cm)
YJTS-425D	Double blister	8/32	10/9	38.5*35*38



YJTS-426

3/8" Ratchet Handle

FEATURES:

- Ratchet handle and sockets exceed national specifications for torque.
- Ratchet handle that is ready for many uses.
- Standard sizes snap-in locking socket tray.
- Ergonomic shaft for better grip.
- CR-V sockets for long lasting.
- Surface: satin finish.

CONTAINS:

- 7pc 3/8" sockets: 8, 10, 12, 13, 14, 17, 19mm.

ITEM	Packaging	Box/carton	Gw/Nw(kg)	MEAS(cm)
YJTS-426D	Double blister	6/24	16/15	41*34.5*38



YJTS-430

1/2" Ratchet Handle

FEATURES:

- Ratchet handle and sockets exceed national specifications for torque.
- Ratchet handle that is ready for many uses.
- Standard sizes snap-in locking socket tray.
- Ergonomic shaft for better grip.
- CR-V sockets for long lasting.
- Surface: satin finish.

CONTAINS:

- 5pc 1/2" sockets: 17, 19, 21, 22, 24mm

ITEM	Packaging	Box/carton	Gw/Nw(kg)	MEAS(cm)
YJTS-430D	Double blister	6/12	11/10	39*21.5*38

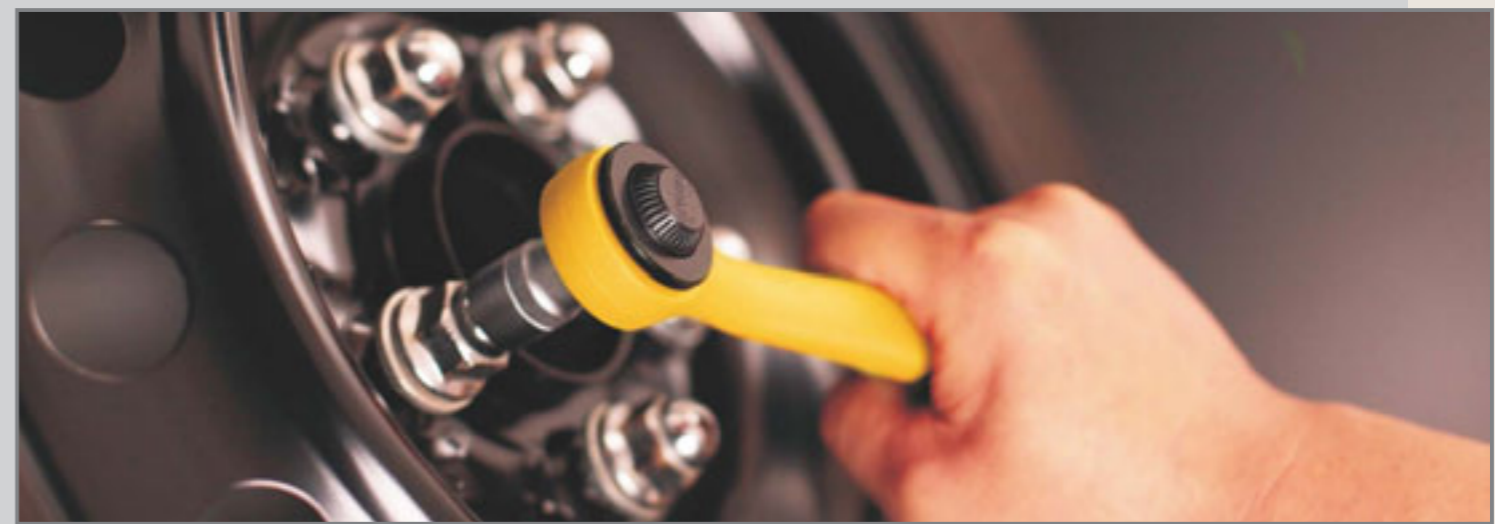

YJTS-427

1/4" Ratchet Handle With Bonus Bag

FEATURES:

- Ratchet handle and sockets exceed national specifications for torque.
- Ratchet handle that is ready for many uses.
- Standard sizes snap-in locking socket tray.
- Ergonomic shaft for better grip.
- CR-V sockets for long lasting.
- Surface: satin finish.

CONTAINS:

- 7pc 1/4" sockets-6, 7, 8, 9, 10, 11, 13mm.

ITEM	Packaging	Box/carton	Gw/Nw(kg)	MEAS(cm)
YJTS-427D	Double blister	6/24	8.2/7.2	37.5*33.5*33.5



YJTS-428

3/8" Ratchet Handle With Bonus Bag

FEATURES:

- Ratchet handle and sockets exceed national specifications for torque.
- Ratchet handle that is ready for many uses.
- Standard sizes snap-in locking socket tray.
- Ergonomic shaft for better grip.
- CR-V sockets for long lasting.
- Surface: satin finish.

CONTAINS:

- 7pc 3/8" sockets: 8, 10, 12, 13, 14, 17, 19mm.

ITEM	Packaging	Box/carton	Gw/Nw(kg)	MEAS(cm)
YJTS-428D	Double blister	6/24	15/14	43.5*38*39.5



YJTS-429

1/2" Ratchet Handle With Bonus Bag

FEATURES:

- Ratchet handle and sockets exceed national specifications for torque.
- Ratchet handle that is ready for many uses.
- Standard sizes snap-in locking socket tray.
- Ergonomic shaft for better grip.
- CR-V sockets for long lasting.
- Surface: satin finish.

CONTAINS:

- 6pc 1/2" sockets: 10, 12, 13, 14, 17, 19mm

ITEM	Packaging	Box/carton	Gw/Nw(kg)	MEAS(cm)
YJTS-429D	Double blister	6/24	22/21	43.5*38*45.5



HOTAK

CRAFT & HOBBY KNIVES

The hobby knife produced in LONGYUAN was originated from 1992. after years of focusing on the quality and development for hobby knife, it has already formed into a high-end series products and towards to refinement and professional development.

SK5 blades for best performance.



HOTAK

The hobby knife in LONGYUAN is mainly aluminum alloy handle and dual-color handle. the material for blade is SK5, which could be more sharp. Meanwhile, there are also combination hobby knife tool sets and the customers can find the types of blades they need more conveniently.

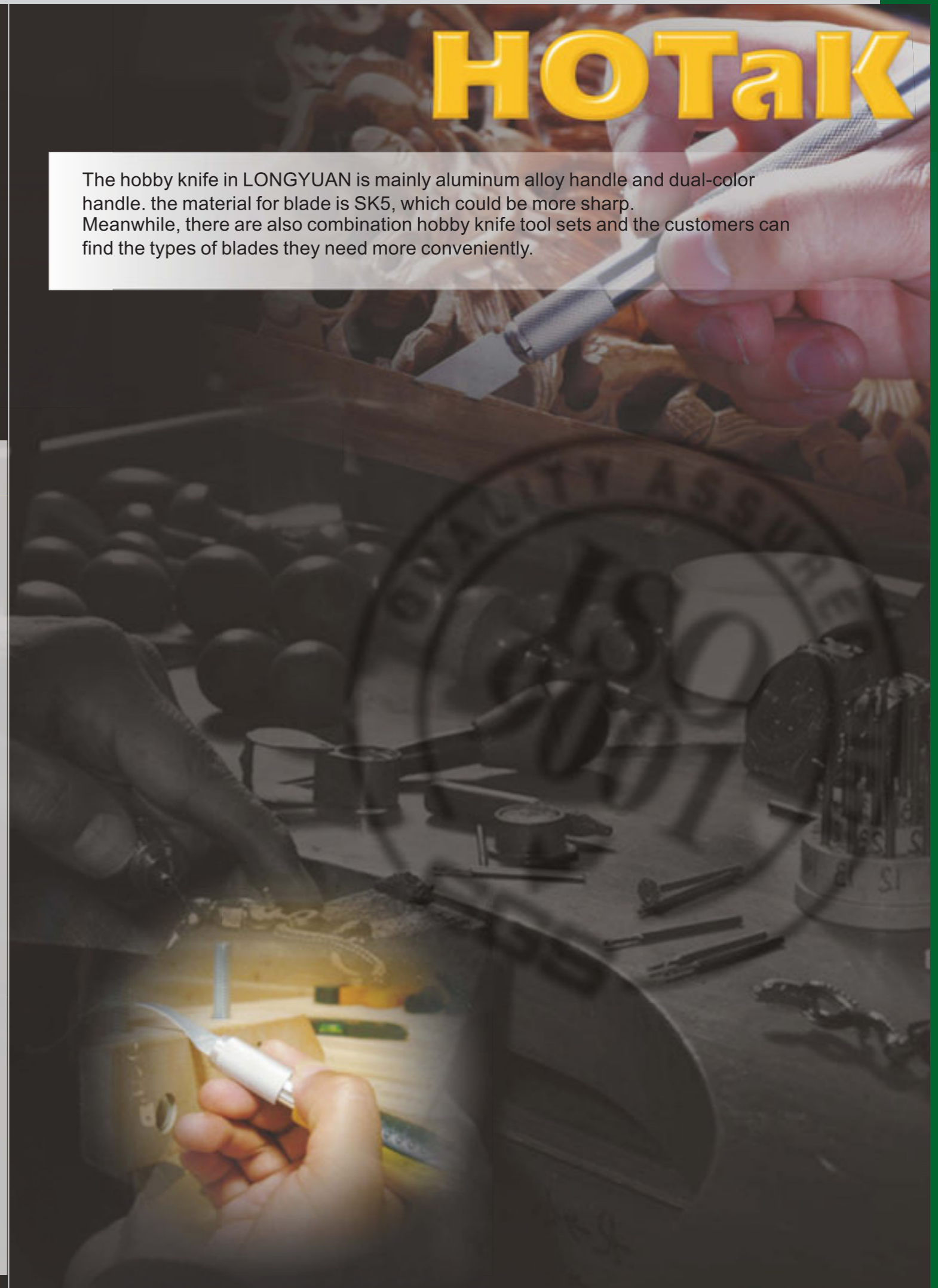

YJCK-467

New Precision Hobby Knife

FEATURES:

- Ergonomic design handle for greater control and comfort.
- Great tools for trimming, deburring, chiseling, carving, cutting and other hobby craftwork.
- Flared end prevents rolling.
- Use when working with denser materials such as cardboard, plastics, linoleum, leather, soft woods, rubber and more.

CONTAINS:

- 5pc blades.
- 1pc rubber coated blades holder.

ITEM	Packaging	Box/carton	Gw/Nw(kg)	MEAS(cm)
YJCK-467D	Double blister	10/60	5.2/4.5	36.5*25.5*39.5



YJCK-464

New Precision Hobby Knife

FEATURES:

- Ergonomic design handle for greater control and comfort.
- Great tools for trimming, deburring, chiseling, carving, cutting and other hobby craftwork.
- Flared end prevents rolling.
- Use when working with denser materials such as cardboard, plastics, linoleum, leather, soft woods, rubber and more.

CONTAINS:

- 5pc blades.
- 1pc rubber coated blades holder.

ITEM	Packaging	Box/carton	Gw/Nw(kg)	MEAS(cm)
YJCK-464D	Double blister	10/60	5.3/4.3	49.5*26*32



YJCK-464

New Precision Hobby Knife

FEATURES:

- Ergonomic design handle for greater control and comfort.
- Great tools for trimming, deburring, chiseling, carving, cutting and other hobby craftwork.
- Flared end prevents rolling.
- Use when working with denser materials such as cardboard, plastics, linoleum, leather, soft woods, rubber and more.

CONTAINS:

- 5pc blades.
- 1pc rubber coated blades holder.

ITEM	Packaging	Box/carton	Gw/Nw(kg)	MEAS(cm)
YJCK-463D	Double blister	10/60	4.5/3.5	36.7*25*32.5



YJCK-2010

Precision Knife Set

FEATURES:

FEATURES:

- Ergonomic design handle for greater control and comfort.
- For cutting, trimming, scoring, and carving soft cushion grip for comfort.
- Classic hobby handle has aluminum barrel and knurled surface grip.

CONTAINS:

- 5pc blades.
- 1pc aluminium thin holder

ITEM	Packaging	Box/carton	Gw/Nw(kg)	MEAS(cm)
YJCK-2010K	Blister card		4.5/3.5	47*25*18.5



YJCK-2011

Precision Knife Set

FEATURES:

- Ergonomic design handle for greater control and comfort.
- For cutting, trimming, scoring, and carving soft cushion grip for comfort.
- Classic hobby handle has aluminum barrel and knurled surface grip.

CONTAINS:

- 5pc blades.
- 1pc aluminium big holder

ITEM	Packaging	Box/carton	Gw/Nw(kg)	MEAS(cm)
YJCK-2011K	Blister card		5/4	52*25*21.5



YJCK-473

17pcs Precision Knife Set

FEATURES:

- Ergonomic design handle for greater control and comfort.
- For cutting, trimming, scoring, and carving soft cushion grip for comfort.
- Handle features comfortable rubber grip and anti-slip nub.
- Classic hobby handle with aluminum barrel and knurled surface grip.

CONTAINS:

- 5pc #11 blades.
- 5pc #17 blades.
- 5pc #2 blades.
- 1pc aluminium thin holder with #11 blade.
- 1pc rubber coated holder with #2 blade.

ITEM	Packaging	Box/carton	Gw/Nw(kg)	MEAS(cm)
YJCK-473D	Double blister	10/100	12.3/11.3	65*43*28.5

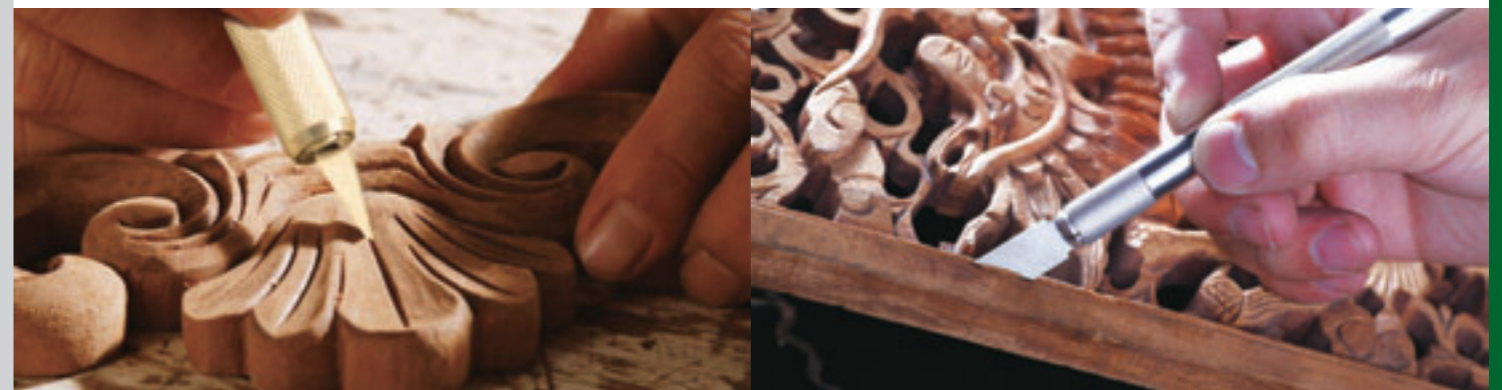

YJCK-468

29pcs Deluxe Hobby Knife Set

FEATURES:

- Use for all kinds of intricate wood working projects.
- Heavy duty rubber grip knife handles provide a secure holding during use.
- Use when working with denser materials such as cardboard, plastics, linoleum, leather, soft woods, rubber and more.

CONTAINS:

- 2pc rubber coated blades holders.
- 1pc deluxe grip blade handle.
- 1pc tweezer.
- 1pc grinding stone.
- 24pc SK5 woodcarving blades.



ITEM	Packaging	Box/carton	Gw/Nw(kg)	MEAS(cm)
YJCK-468D	Double blister	5/20	12.4/11.4	59.5*31*46.5

YJCK-4468

30pcs Deluxe Hobby Knife Set

FEATURES:

- Use for all kinds of intricate wood working projects.
- Heavy duty rubber grip knife handles provide a secure holding during use.
- Use when working with denser materials such as cardboard, plastics, linoleum, leather, soft woods, rubber and more.

CONTAINS:

- 2pc rubber coated blades holders.
- 1pc deluxe grip blade handle.
- 1pc tweezer.
- 1pc grinding stone.
- 1pc auminum bit handle.
- 24pc SK5 woodcarving blades.



ITEM	Packaging	Box/carton	Gw/Nw(kg)	MEAS(cm)
YJCK-4468D	Double blister	5/20	13/12	59.5*31*46.5



YJCK-462

33pcs Deluxe Hobby Knife Set

FEATURES:

- Heavy duty rubber grip knife handles provide a secure holding during use.
- Great for model making arts and crafts or any hobby for cutting paper, plastic, metal and etc Interchangeable blades for different rate of.

CONTAINS:

- 3pc rubber coated blades holders.
- 1pc deluxe grip blade handle.
- 24pc SK5 woodcarving blades.
- 2pc scratch awl blades.
- 1pc pair of tweezers .
- 1pc plastic caliper.
- 1pc precision jewelers screwdriver.

ITEM	Packaging	Box/carton	Gw/Nw(kg)	MEAS(cm)
YJCK-462D	Double blister	5/20	13.2/12.2	59.5*31*46.5



YJCK-4462

34pcs Deluxe Hobby Knife Set

FEATURES:

- Heavy duty rubber grip knife handles provide a secure holding during use.
- Great for model making arts and crafts or any hobby for cutting paper, plastic, metal and etc Interchangeable blades for different rate of.

CONTAINS:

- 3pc rubber coated blades holders.
- 1pc deluxe grip blade handle.
- 24pc SK5 woodcarving blades.
- 2pc scratch awl blades.
- 1pc pair of tweezers .
- 1pc plastic caliper.
- 1pc precision jewelers screwdriver.
- 1pc 0.08 in. slotted precision screwdriver.

ITEM	Packaging	Box/carton	Gw/Nw(kg)	MEAS(cm)
YJCK-4462D	Double blister	5/20	14/13	59.5*31*46.5



HOTAK

YJCK-4013

35pcs Deluxe Hobby Knife Set

FEATURES:

- Heavy duty rubber grip knife handles provide a secure holding during use.
- Great for model making arts and crafts or any hobby for cutting paper, plastic, metal and etc Interchangeable blades for different rate of.

CONTAINS:

- 2pc rubber coated blades holder.
- 28pc sk5 wood carving blades.
- 2pc scratch awl blades.
- 1pc tweezers.
- 1pc plastic caliper.
- 1pc precision screwdriver.



ITEM	Packaging	Box/carton	Gw/Nw(kg)	MEAS(cm)
YJCK-4013D	Double blister	5/20	12.7/11.7	59.5*31*46.5

YJCK-4014

36pcs Deluxe Hobby Knife Set

FEATURES:

- Heavy duty rubber grip knife handles provide a secure holding during use.
- Great for model making arts and crafts or any hobby for cutting paper, plastic, metal and etc Interchangeable blades for different rate of.

CONTAINS:

- 2pc rubber coated blades holder.
- 28pc SK5 wood carving blades.
- 2pc scratch awl blades.
- 1pc tweezers.
- 1pc plastic caliper.
- 1pc precision screwdriver.
- 1pc 0.08 in. Slotted precision screwsriver.



ITEM	Packaging	Box/carton	Gw/Nw(kg)	MEAS(cm)
YJCK-4014D	Double blister	5/20	13/12	59.5*31*46.5

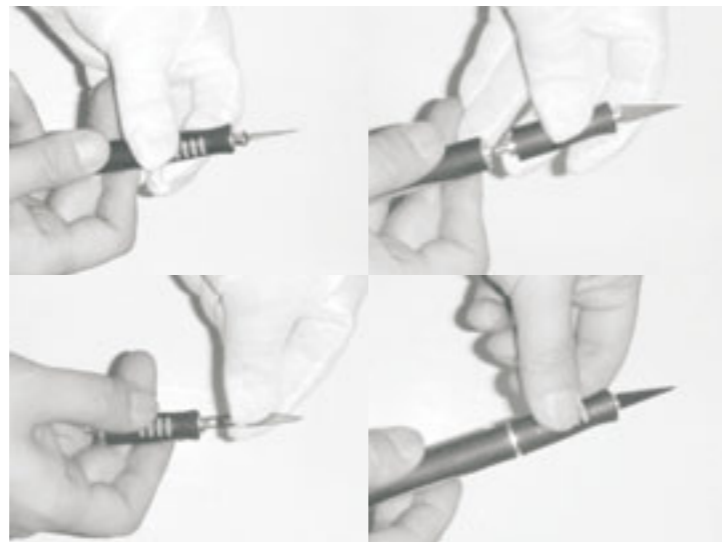

YJCK-454

17pcs Craft And Hobby Knife Set

FEATURES:

- Ergonomic design handle for greater control and comfort.
- For cutting, trimming, scoring, and carving soft cushion grip for comfort.
- Handle features anti-roll nub.

CONTAINS:

- 13pc blades
- 1pc tweezers.
- 3pc aluminium thin handles

ITEM	Packaging	Box/carton	Gw/Nw(kg)	MEAS(cm)
YJCK-454B	Shrink	12/36	15.5/14.5	45*22*31.5

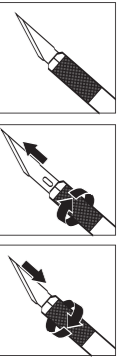

YJCK-4450

51pcs Deluxe Hobby Knife Set

FEATURES:

- Plastic carry case packed.
- Aluminum precision knife handles provide a secure holding during use.
- Great for model making arts and crafts or any hobby For cutting paper, plastic, metal and etc Interchangeable blades for different rate of.

CONTAINS:

- 6pc modelling knives with aluminium handle
- 42pc blades
- 1pc grindstone
- 1pc glue

ITEM	Packaging	Box/carton	Gw/Nw(kg)	MEAS(cm)
YJCK-4450D	Double blister	10	7.8/6.8	40*39*29

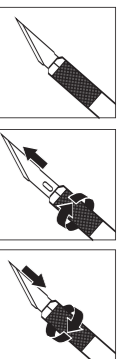

YJCK-4110

57pcs Deluxe Hobby Knife Set

FEATURES:

- Plastic carry case packed.
- Aluminum precision knife handles provide a secure holding during use.
- Great for model making arts and crafts or any hobby For cutting paper, plastic, metal and etc Interchangeable blades for different rate of.

CONTAINS:

- 7pc modelling knives with aluminium handle
- 47pc blades made from carbon steel
- 1pc modelling knife with non-slip plastic handle
- 1pc grindstone
- 1pc glue

ITEM	Packaging	Box/carton	Gw/Nw(kg)	MEAS(cm)
YJCK-4110D	Double blister	10	8.2/7.2	40*39*29

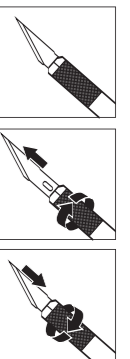

YJCK-458

Multi-purpose Rotary Cutter

FEATURES:

- Great for medium to heavy-duty projects.
- Ergonomic scalloped design.
- Comfortable handle and dual-action safety lock.
- Perfect for scrapbooking, card making, crafts, unique edging on quilts etc.
- Makes fabric cutting and scrapbooking easy.
- Comfortable ergonomic handle for right and left handed professionals and hobbyists.



HAND SAW

LONGYUAN superior hand saws are all made of high-level alloy steel. with its special design in meeting customers' physical demand, our saws are more convenient in gardening usage.

Adopting more advanced three surface grinding technologies; our saw bits with SK5 alloy steel can improve the work efficient to a great extent.

 **Treble cutting-edge teeth**

 **Impulse-hardening**

 **Chrome plated**



HOTAK

Faster tri-bevel teeth cut aggressively on both the push and pull stroke to provide faster cut speeds.

Triple ground teeth for fast cutting.

Saw blade with aggressive teeth, impulsion hardened.

Beveled teeth cut in both directions Comfort-cushion grip.

Ergonomic designed handle for the most comfort grip. Leaf blades are made of SK5 steel, treble cutting-edge teeth, impulsion harden. Versatile cuts a wide range of materials: wood, plastic, PVC, cement board and drywall.



YJHS-1201

Folding Pruning Saw

- Treble cutting-edge teeth
- Impulse-hardening
- Chrome plated



FEATURES:

- Handle ergonomic angle allows higher torque transmission. Specially SK5 high quality Steel for tough-hard blades, exceptional elasticity together with high hardness, guarantees an extremely tough cutting edge resistant to fracture and thus accident-proof. The blade are hardened and tempered along their entire length.
- Folding construction, cutting angle adjustable.
- Only one type for all application, easier to use-safe to work with.
- Comfortable non-fatigue patented aluminium+TPR handle.
- SK5 Leaf blade with treble cutting-edge teeth, impulsion harden.
- Thickness of blade 0.9mm, 200 mm leaf blade, 10 teeth /30mm.



ITEM	Packaging	Box/carton	Gw/Nw(kg)	MEAS(cm)
YJHS-1201D	Double blister	6/24	15/14	36.5*37*33
YJHS-1201C	Color box	10/40	13/12	3.5*33*33.5

YJHS-1302

Max Pruning Saw



FEATURES:

- Handle ergonomic angle allows higher torque transmission.
- Specially SK5 high quality Steel for tough-hard blades, exceptional elasticity together with high hardness, guarantees an extremely tough cutting edge resistant to fracture and thus accident-proof. The blade are hardened and tempered along their entire length.
- Only one type for all application, easier to use-safe to work with.
- Comfortable non-fatigue patented plastic handle.
- SK5 Leaf blade with treble cutting-edge teeth, impulsion harden.

ITEM	Packaging	Box/carton	Gw/Nw(kg)	MEAS(cm)
YJHS-1302D	Double blister	6/24	7.6/6.6	46.7*34*30

YJHS-1401

Folding Round Handsaw

To open or close the blade push and hold the unlock button

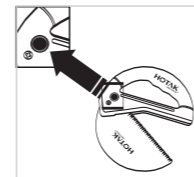

FEATURES:

- Aggressive, tri-bevel cut.
- Alloy steel blade with rust protection.
- Impulse induction hardened teeth.
- Durable soft-grip handle, blade opened or closed by pushing a button.

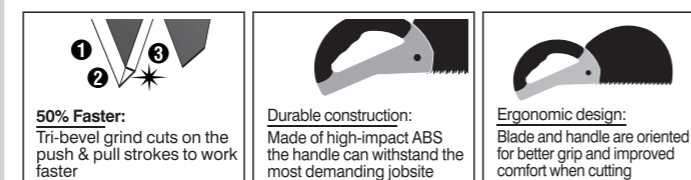

ITEM	Packaging	Box/carton	Gw/Nw(kg)	MEAS(cm)
YJHS-1401D	Double blister	6/24	15/14	36.5*37*33

YJHS-1601

Multi Purpose Magic Saw



FEATURES:

- High quality material for long life time.
- Compact design for easy carrying.

APPLICATION:

- DIY design, art & craft, vehicles, manufacturing, plumbing, carpentry, cutting wood, aluminium, nails, rubber, PVC.

ITEM	Packaging	Box/carton	Gw/Nw(kg)	MEAS(cm)
YJHS-1601C	Color box	6/24	4.7/3.7	37.5*30.5*23.5

YJHS-1602

Multi Purpose Magic Saw

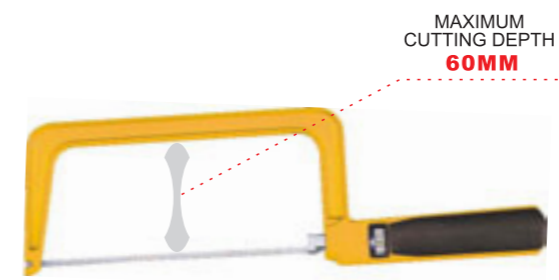

FEATURES:

- High quality material for long life time.
- Compact design for easy carrying.

APPLICATION:

- DIY design, art & craft, vehicles, manufacturing, plumbing, carpentry, cutting wood, aluminium, nails, rubber, PVC.

ITEM	Packaging	Box/carton	Gw/Nw(kg)	MEAS(cm)
YJHS-1602C	Color box	6/24	3.8/2.8	30.5*23.5*23.5

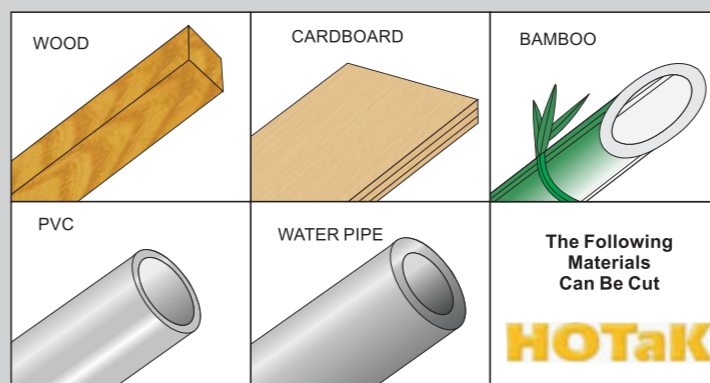

YJHS-1701

5-in-1 Drywall Tool

CONTENTS:

- 1pc Keyhole saw
- 1pc Utility knife
- 1pc Sanding rasp
- 1pc Tube Punch
- 1pc Screw pull
- 1pc blade storage



FEATURES:

- SK5 saw blade with aggressive teeth, impulsion hardened.
- Cuts drywall, wallboard, plywood and plastic.
- Triple ground teeth for fast cutting.
- Blade cuts in both direction (push and pull).
- Comfort-cushion grip with thumb groove for curve cutting.

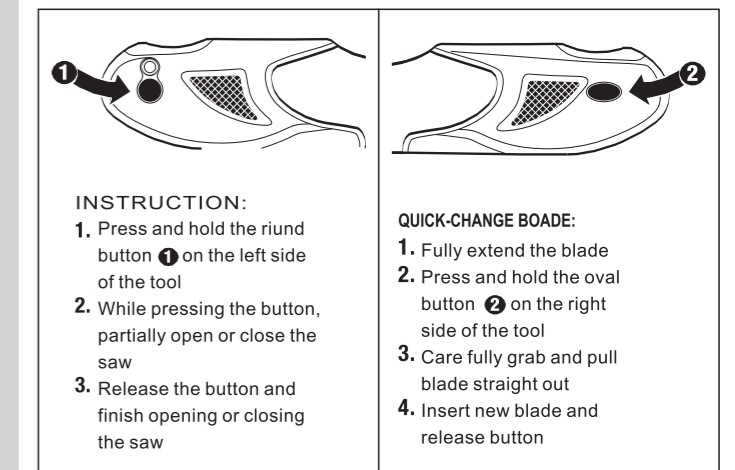

INSTRUCTION:

- Press and hold the round button ① on the left side of the tool
- While pressing the button, partially open or close the saw
- Release the button and finish opening or closing the saw

QUICK-CHANGE BOADE:

- Fully extend the blade
- Press and hold the oval button ② on the right side of the tool
- Care fully grab and pull blade straight out
- Insert new blade and release button



ITEM	Packaging	Box/carton	Gw/Nw(kg)	MEAS(cm)
YJHS-1701D	Double blister	6/24	10.7/9.7	73.5*38*30.5

HOTAK